

Your **HTC** Flyer

User guide

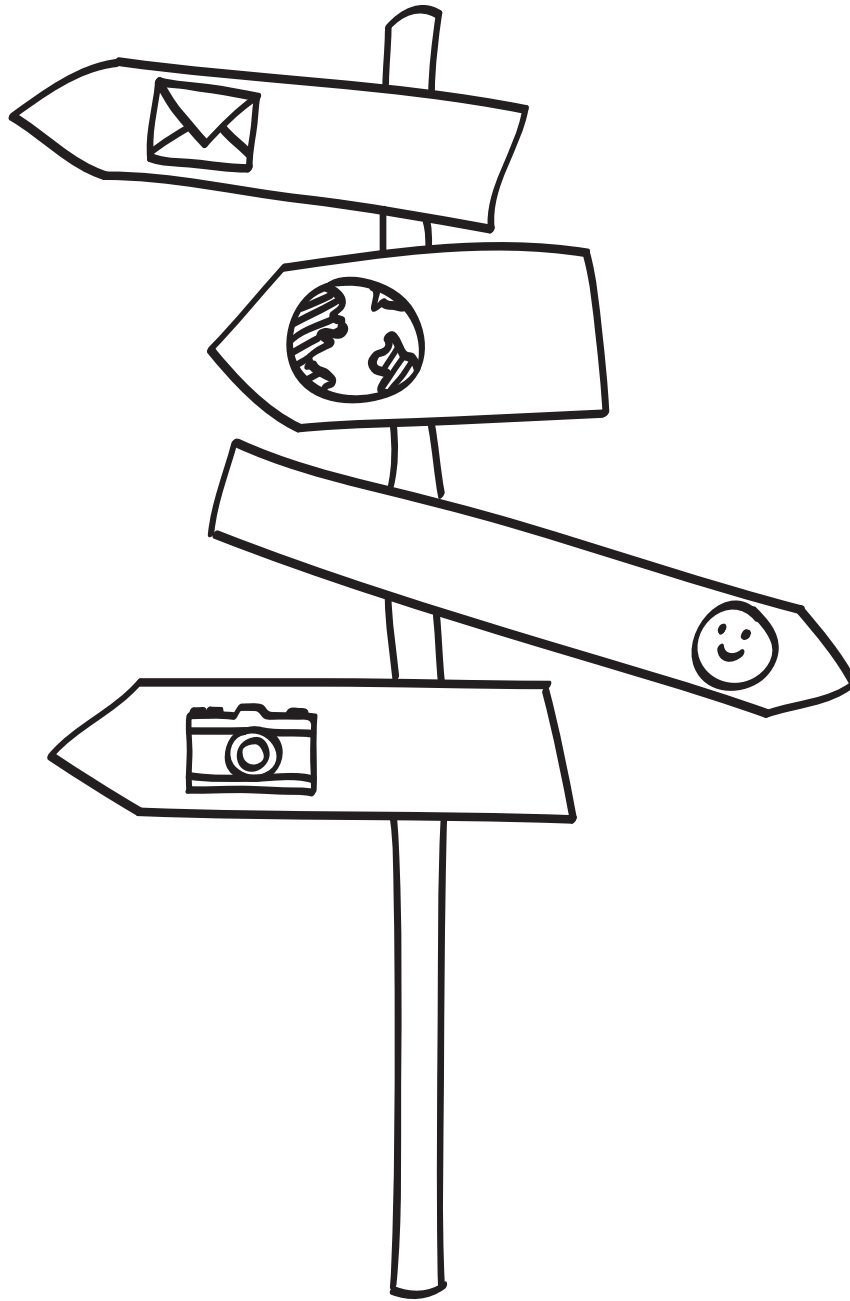

Contents

Getting started

Inside the box	8
HTC Flyer	8
Top cover	10
SIM card	11
Storage card	12
Battery	13
Switching the power on or off	13
Entering your PIN	14
Finger gestures	14
Setting up HTC Flyer for the first time	15
Ways of getting contacts into HTC Flyer	15
Home screen	16

Basics

Adjusting the volume	18
Sleep mode	18
Status and notifications	19
Notifications panel	22
Connecting HTC Flyer to a computer	23
Copying files to or from the internal storage or storage card	24
Copying text, looking up information, and sharing	25
Printing	26

Personalizing

Making HTC Flyer truly yours	28
Personalizing HTC Flyer with scenes	28
Changing your wallpaper	29
Applying a new skin	30
Personalizing your Home screen with widgets	30
Adding icons and other shortcuts on your Home screen	32
Adding folders on your Home screen	32
Rearranging or removing widgets and icons on your Home screen	33
Customizing the launch bar	33
Rearranging the Home screen	34
Using sound sets	34
Rearranging or hiding application tabs	36

Search and Web browser

Searching HTC Flyer and the Web	38
Using the web browser	40
Downloading from the Web	42

Viewing bookmarks and previously visited pages	42
Setting browser options	44

Tablet pen and fun apps

About the tablet pen	45
Choosing your pen type, color, and stroke	46
Highlighting and drawing in pen-integrated apps	48
Scribbling	50
About Notes	51
Writing a note	52
Reviewing a note	53
Sketching	54
Managing your sketches	56
Switching to Kid Mode	57

Snapbooth and Camera

Snapbooth	59
Camera	60

Photos, videos, and music

Gallery	65
Music	73
Connected Media	77

HTC services

HTC Watch	79
Signing up for your HTC Sense.com account	79
Using HTC Sense.com	80
Deleting your HTC Sense.com account	81

Accounts and sync

About online accounts	82
Synchronizing with a Google Account	82
Adding a social network account	83
Managing your online accounts	83

Social

Facebook for HTC Sense	85
Facebook app	86
What's the difference between Facebook app and Facebook for HTC Sense?	87
Twitter for HTC Sense	87
Using Friend Stream	88
Tweeting in Friend Stream	91
Chatting in Google Talk	92

Email

Gmail	95
Mail	96

Calendar

About Calendar	105
Creating an event	105
Changing Calendar views	107
Managing Calendar events	108
Dismissing or snoozing event reminders	109
Showing or hiding calendars	109
Changing Calendar settings	110
About the Calendar widget	110

Maps and location

Turning on location services	111
About Locations	111
Finding your location and what's around you	111
Searching for a place of interest	112
Searching for an address	112
Viewing maps	113
Recording favorite places as footprints	114
Getting directions	116
Using turn-by-turn navigation (Premium navigation)	118
Using Car Panel	119
Managing Locations services	120
Downloading maps or purchasing services	120
Adding navigation widgets	121
About Google Maps	121
Getting around maps	121
Searching for a location	122
Searching for a place of interest near you	123
Getting directions	123
Getting help	124
Finding your friends with Google Latitude (available by country)	124

People

Transferring contacts from your old phone	125
About the People app	126
Setting up your profile	127
Importing contacts from your SIM card	127
Adding a new contact	128
Importing a contact from an Exchange ActiveSync account	128
Merging contact information	129
Filtering your contacts list	130
Backing up your contacts to the storage card	131
Contact information and conversations	131
Sending contact information as a vCard	132
Contact groups	133
Adding People widgets	135

Messages

Opening Messages	137
Sending a text message (SMS)	137
Sending a multimedia message (MMS)	138
Resuming a draft message	140

Viewing and replying to a message	140
Previewing message conversations	142
Viewing and saving an attachment from a multimedia message	142
Push messages	143
Managing message conversations	144
Setting message options	145

Market and other apps

Finding and installing apps from Android Market	147
Using the Clock	149
Checking Weather	152
Reading eBooks	153
Reading news feeds	156
Keeping track of your stocks	158
Watching videos on YouTube	159
Sharing games and apps	161

HTC Sync

About HTC Sync	162
Installing HTC Sync that came with the storage card	163
Setting up HTC Sync to recognize your phone	163
Getting to know the workspace	164
Setting up synchronization	164
Synchronizing your phone	168
Installing an app from your computer to your phone	169
Downloading maps or purchasing services	169
Synchronizing another phone with your computer	170
Downloading the latest HTC Sync upgrade	170

Keyboard

Using the onscreen keyboard	171
Entering words with predictive text	172
Entering text by speaking	174
Entering text by tracing	174
Editing text	175
Adjusting input settings	176

Internet connections

Data connection	177
Wi-Fi	178
About connection widgets	180
Connecting to a virtual private network (VPN)	180
Using HTC Flyer as a modem (USB tethering)	181
Connecting HTC Flyer to the Internet through a computer (Internet Pass-through)	182
Using HTC Flyer as a wireless router	182

Bluetooth

Bluetooth basics	183
Connecting a Bluetooth headset or car kit	183
Disconnecting or unpairing from a Bluetooth device	184
Sending information using Bluetooth	185

Receiving information using Bluetooth	187
---------------------------------------	-----

Security

Protecting your SIM card with a PIN	189
Protecting HTC Flyer with a screen lock pattern, PIN, or password	189

Settings

Settings on HTC Flyer	191
Changing display settings	192
Changing sound settings	194
Changing the language	194
Optimizing battery life	194
Managing memory	195
Checking information about HTC Flyer	196

Update and reset

Software updates	197
Restarting HTC Flyer	198
Resetting HTC Flyer	198

Trademarks and copyrights

Index

Conventions used in this guide

In this user guide, we use the following symbols to indicate useful and important information:



This is a note. A note often gives additional information, such as what happens when you choose to do or not to do a certain action. A note also provides information that may only be applicable to some situations.



This is a tip. A tip gives you an alternative way to do a particular step or procedure, or lets you know of an option that you may find helpful.



This indicates important information that you need in order to accomplish a certain task or to get a feature to work properly.



This provides safety precaution information, that is, information that you need to be careful about to prevent potential problems.

Getting started

Inside the box

You will find the following inside the box:

- HTC Flyer
- Tablet pen
- Tablet pen battery
- USB cable
- Power adapter
- 3.5mm stereo headset
- Protective case
- Quick guide
- Safety and regulatory guide
- Call center card (hotline card)
- Warranty card

HTC Flyer

Front panel

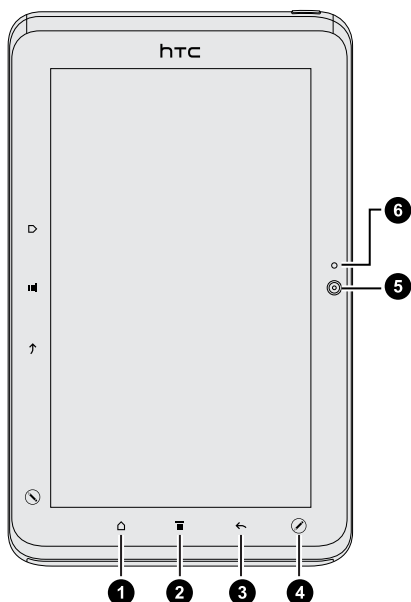

1. HOME
2. MENU
3. BACK
4. PEN OPTIONS
5. Front camera
6. Front camera on or off indicator

Right panel

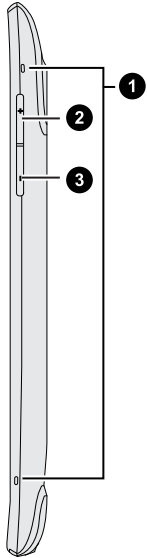

1. Microphones
2. VOLUME UP
3. VOLUME DOWN

Back panel

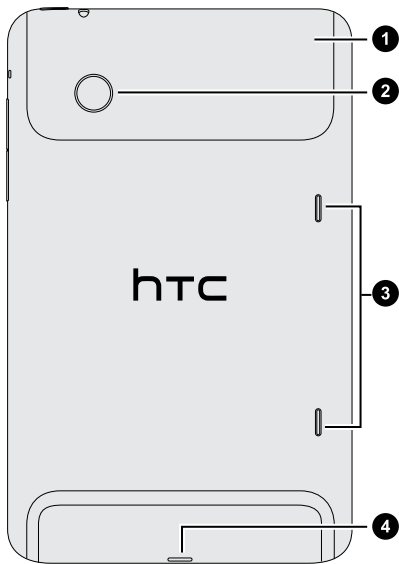

1. Top cover
2. 5 megapixel camera
3. Speakers
4. USB connector

Top panel

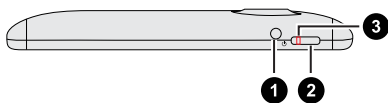

1. 3.5mm headset jack
2. POWER
3. Notification LED

Top cover

Removing the top cover

Remove the top cover to access the SIM card and storage card slots.

1. Turn off HTC Flyer and hold it securely with the front facing down.
2. With your right and left thumbs, push the top cover out to remove it.

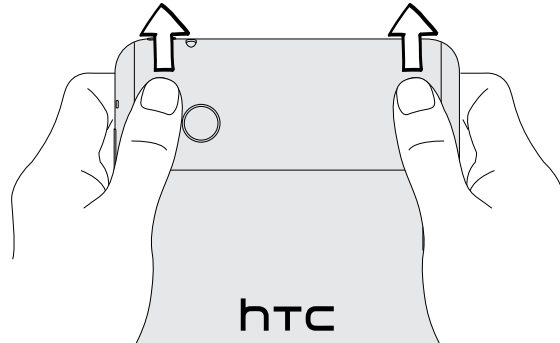

Replacing the top cover

1. Align the two teeth underneath the top cover (one on each side) with the two notches on the top of HTC Flyer.

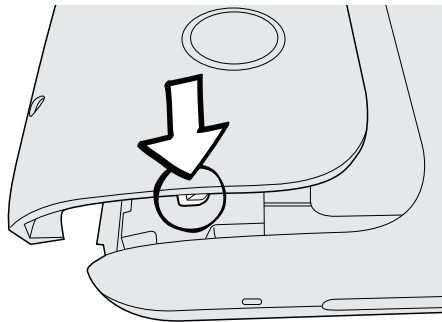

2. Place the top cover on HTC Flyer, gently press down on the cover with your thumbs, and then push it in until it clicks and locks into place.

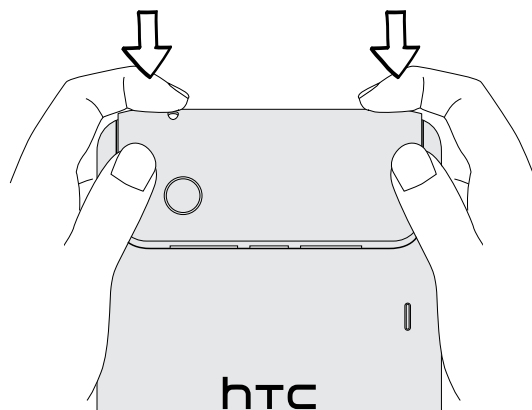

SIM card

You'll need a SIM card inserted in HTC Flyer to use a data connection. Both 1.8V and 3V SIM cards can be used.



Some legacy SIM cards may not function with HTC Flyer. You should consult with your mobile operator for a replacement SIM card. There may be fees for this service.

Inserting the SIM card

1. Turn off HTC Flyer and hold it securely with the front facing down.
2. Take the top cover off
3. With the SIM card's gold contacts facing down and its cut-off corner facing out, insert the SIM card into the SIM card slot.

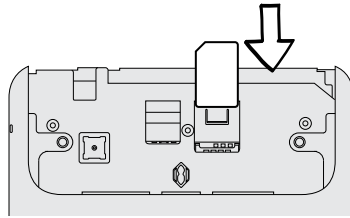

Removing the SIM card



Make sure to switch off HTC Flyer before removing your SIM card.

1. Take the top cover off
2. With your finger, press down the small tab located near the opening of the SIM card slot.

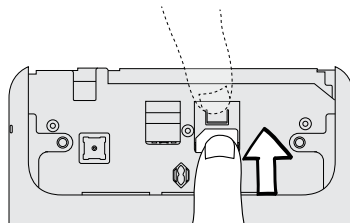

3. Slide the SIM card out from the SIM card slot.

Storage card

HTC Flyer comes with an internal storage that you can use to store your photos, videos, and music. If you need more storage space, you can insert a storage card into HTC Flyer.

Inserting the storage card

1. Take the top cover off
2. Insert the storage card into the storage card slot with its gold contacts facing down and push it until it clicks into place.

Removing the storage card



If HTC Flyer is on you must first "unmount" the storage card before removing it to prevent corrupting or damaging the files in the storage card.

1. Take the top cover off
2. Push the storage card in to eject it from its slot.
3. Slide the storage card out from its slot.

Unmounting the storage card

When you need to remove the storage card while HTC Flyer is on, unmount the storage card first to prevent corrupting or damaging the files in the storage card.

1. From the Home screen, press , and then tap **Settings**.
2. Tap **SD & phone storage > Unmount SD card**.

Battery

HTC Flyer uses a rechargeable battery. How long the battery can last before it needs recharging depends on how you use HTC Flyer. Among these are the features and accessories you use (for example, leaving your Bluetooth™ connection always on uses more power). Frequent web browsing uses up a lot of battery power. Also, consider your location: poor signal strength from your mobile network and extreme temperature make the battery work harder.

Charging the battery

The battery is partially charged when shipped. Before you turn on and start using HTC Flyer, it is recommended that you charge the battery. Some batteries perform best after several full charge/discharge cycles.



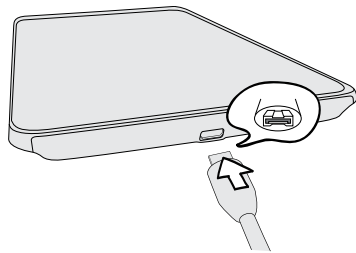

Only the power adapter provided in the box must be used to charge the battery.

1. Plug the power adapter into the USB connector of HTC Flyer.



2. Plug in the power adapter to an electrical outlet to start charging the battery.

As the battery is being charged, the notification LED shows a solid orange light. The light turns to solid green when HTC Flyer is fully charged.

When you charge the battery while HTC Flyer is on, the charging battery icon  is displayed in your tablet's status bar. After the battery has been fully charged, the charging battery icon turns to a full battery icon .



As a safety precaution, the battery stops charging when it overheats.

Switching the power on or off

Switching the power on

Press the POWER button. Easy.



When you turn on HTC Flyer for the first time, you'll need to set it up.

Switching the power off

1. If the display is off, press the POWER button to turn it back on, then unlock the screen.
2. Press and hold the POWER button for a few seconds.
3. When the Power options menu appears, tap **Power off**.

Entering your PIN

Most SIM cards come with a PIN (personal identification number) set by your mobile operator. If you're asked for a PIN, enter it and then tap **OK**.



If you enter the wrong PIN three times, your SIM card is blocked. No problem. Just contact your mobile operator and ask for the PUK (PIN Unblocking Key).

Finger gestures

Tap	When you want to type using the keyboard, select items onscreen such as application and settings icons, or press onscreen buttons, simply tap them with your finger.
Press and hold	To open the available options for an item (for example, a contact or link in a web page), simply press and hold the item.
Swipe or slide	To swipe or slide means to quickly drag your finger vertically or horizontally across the screen.
Drag	Press and hold your finger with some pressure before you start to drag. While dragging, do not release your finger until you have reached the target position.
Flick	Flicking the screen is similar to swiping, except that you need to swipe your finger in light, quicker strokes. This finger gesture is always in a vertical direction, such as when flicking the contacts or message list.
Rotate	For most screens, you can automatically change the screen orientation from portrait to landscape by turning HTC Flyer sideways. When entering text, you can turn HTC Flyer sideways to bring up a bigger keyboard.
Pinch	In some apps, like Gallery or the web browser, you can “pinch” the screen using two fingers (for example, thumb and index finger) to zoom in or zoom out when viewing a picture or a web page.

Setting up HTC Flyer for the first time

When you switch on HTC Flyer for the first time, you'll be asked to set it up. You can choose your language, how you want to connect to the Internet, and whether you want your current location to be automatically detected. If you still have personal contacts and calendar events stored on your old phone, you can easily transfer them to HTC Flyer through Bluetooth as well.

Be sure to sign in to your Google Account so you can use Google apps like Gmail™ and Android Market™. You can also set up your other email accounts, favorite social networks like Facebook and Twitter™, and more.

Just follow the onscreen instructions and you'll be up and running in no time.



Some features that need to connect to the Internet such as location-based services and auto-sync of your online accounts may incur extra data fees from your mobile operator. Don't worry. You can enable or disable them in settings later on.

Ways of getting contacts into HTC Flyer

There are several ways you can add contacts to HTC Flyer. You can sync HTC Flyer with contacts from your Google Account, computer, Facebook, and more.

HTC Sync	Sync the contacts from your old phone to your computer, and then use HTC Sync to sync HTC Flyer with your computer's Microsoft Outlook, Outlook Express or Windows Contacts.
Gmail	Google contacts are imported to HTC Flyer after you sign in to your Google Account. You can also create more Google contacts right from HTC Flyer.
Facebook	Log in to your Facebook account through Facebook for HTC Sense to import your Facebook friends' contact information.
Phone contacts	You can choose to create and store contacts directly in HTC Flyer or transfer existing ones from your old phone.
SIM card	Copy all your SIM contacts to HTC Flyer.
Microsoft Exchange ActiveSync	HTC Flyer syncs your work contacts from the Microsoft Exchange ActiveSync Server in your workplace.
Transfer	Use the Transfer app to transfer not only your contacts, but also calendar events and text messages from your old phone to HTC Flyer.

Home screen

Your Home screen is where you make HTC Flyer your own. It comes with a weather clock widget that shows the time and weather in your current location. You can also add your favorite applications, shortcuts, folders and widgets so they're always just a tap away. To find out how, see [Personalizing](#) on page 28.

Extended Home screen

As you start to do more things with HTC Flyer, you might find that one Home screen is not enough. No problem. You can use up to seven extra screens. It should be plenty.

Slide your finger horizontally to the left or right and you'll discover more space for adding icons, widgets, and more.



Press  to return to the main Home screen (that is, the left-most home screen).

Using Leap view

To jump straight to the screen that you want, press  or pinch the screen to show the Leap view. It reveals all eight Home screens as thumbnails.



Just tap the one you want and you'll leap right there.

Basics

Adjusting the volume

Change the volume levels for alarms, notifications, and when you're playing back music or video on HTC Flyer.

Adjusting the media volume

Press the VOLUME UP or VOLUME DOWN button to adjust the volume. The Media volume window appears on the screen to display the volume level.

Adjusting the volume via settings

1. From the Home screen, press , and then tap **Settings > Sound > Volume**.
2. Drag the volume sliders to the left or right to adjust the volume levels of media playback, alarms, and notifications. A sample tone is briefly played with the volume being adjusted as you drag a slider.
3. When you're done, tap **OK**.

Sleep mode

Sleep mode saves battery power by putting HTC Flyer into a low power state while the display is off. It also stops accidental button presses when HTC Flyer is in your bag. You'll still receive messages though.

Switching to Sleep mode

Briefly press the POWER button to turn off the display and switch to Sleep mode. HTC Flyer also automatically goes into Sleep mode when it's idle for a while.

Waking up from Sleep mode

To wake HTC Flyer up manually, press the POWER button. You'll need to unlock the screen.



HTC Flyer automatically wakes up when you have an event reminder or set an alarm.

Unlocking the screen

Do one of the following:

- Drag up the ring (until the whole ring is shown onscreen), and then release your finger to unlock the screen.



If you have set up a screen unlock pattern, pin, or password, you will be asked to draw the pattern on the screen or enter the PIN or password before it unlocks.

- On the lock screen, you'll see icons for different apps. Drag one of the icons to the ring to open the app.
- If you've set an event reminder or an alarm, you can drag or to the ring to snooze or dismiss the event or alarm.

Status and notifications

Status icons



Here's what each icon means:

	Signal strength		Battery is full
	Roaming		Battery is charging
	No signal		Battery is low (20% remaining)







 GPRS connected	 Battery is very low (10% remaining)
 GPRS in use	 Silent mode
 EDGE connected	 Vibrate mode
 EDGE in use	 Wired microphone headset connected
 3G connected	 Wired headset connected
 3G in use	 Bluetooth is on
 HSDPA connected	 Connected to a Bluetooth device
 HSDPA in use	 Airplane mode
 No SIM card installed	 GPS is on
 Connected to a Wi-Fi network	 Alarm is set
 Data synchronizing	





















Notification icons

Notification icons on the status bar make it easy for you to keep on top of your messages, calendar events, and alarms.



Here's what each one means:

 New Gmail message	 Compass needs orientation
 New Microsoft Exchange ActiveSync or POP3/IMAP email	 More (not displayed) notifications
 Problem with email delivery	 General notification

 New SMS/MMS	 HTC Flyer is connected to a computer via USB cable
 Problem with SMS/MMS delivery	 Wi-Fi is on and wireless networks are available
 New Google Talk instant message	 Portable Wi-Fi Hotspot is on
 New voicemail	 Uploading data (animated)
 Upcoming event	 Downloading data (animated)
 New updates from your social networks	 Waiting to upload
 Matched contacts suggestion	 Downloaded Android Market app installed successfully
 Bluetooth pairing request	 Update available for an app downloaded from Android Market
 HTC Flyer software update available	 Storage card is safe to remove or storage card is being prepared
 Song is playing	 Storage card or internal storage is low on free space

Notification LED



The notification LED shows a:

- Solid green light when HTC Flyer is connected to the power adapter or a computer and the battery is fully charged.
- Flashing green light when you have a pending notification.
- Solid orange light when the battery is being charged.
- Flashing red light when the battery level reaches very low.

Notifications panel

When you get a new notification, you can open the Notifications panel to see the message, reminder or event notification. The Notifications panel lets you quickly switch between recently-opened apps, and also lets you easily turn on settings such as Wi-Fi and Bluetooth.

To open the Notifications panel, press and hold the status bar, then slide your finger downward.

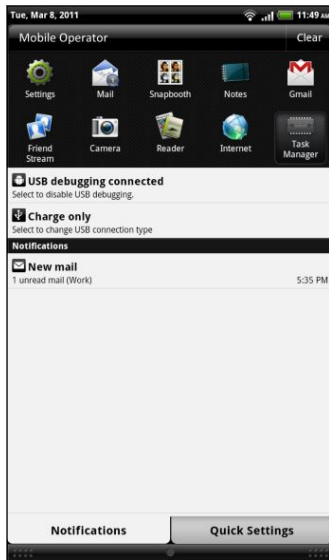

If you have several notifications, you can scroll down the screen to see them all.



You can also open the Notifications panel on the Home screen by pressing  and then tapping Notifications.

Switching between recently opened apps

On the Notifications panel, you can easily access up to ten apps you just recently opened.

1. Press and hold the status bar, then slide your finger downward to open the Notifications panel.
2. In the Recent apps section, tap an app to open it.



Press and hold  to view recently used apps.

Using Quick Settings

The Quick Settings tab lets you easily turn on Wi-Fi, Bluetooth, GPS, and more, and also provides a quick shortcut to all HTC Flyer settings.

1. Press and hold the status bar, then slide your finger downward to open the Notifications panel.
2. Tap the Quick Settings tab.
3. Tap the check box next to an item to turn it off or on.

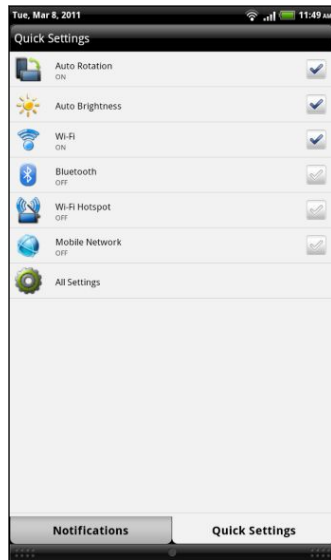

Closing the Notifications panel

Press and hold the bottom bar of the Notifications panel, then slide your finger up the screen. Or just press .

Connecting HTC Flyer to a computer

Whenever you connect HTC Flyer to a computer using the USB cable, the Connect to PC screen opens and lets you choose the type of USB connection.

Select one of the following choices, and then tap **Done**:

Charge only	Select this option if you only want to charge the battery while HTC Flyer is connected to your computer.
HTC Sync	Select this option to synchronize contacts, calendar, and other information between your computer and HTC Flyer.

Disk drive	Select this mode when you want to copy files between the internal storage of HTC Flyer or storage card (if one is inserted) and your computer. When Disk drive mode is enabled while HTC Flyer is connected to the computer, you will not be able to use apps on HTC Flyer to access the internal storage or storage card (if one is inserted).
USB tethering	When you do not have Internet connection on your computer, you can select this mode to share the mobile data connection of HTC Flyer with your computer.
Internet pass-through	If you don't have a data plan or you don't have access to a Wi-Fi network, you can select this mode to share your computer's Internet connection with HTC Flyer.

Copying files to or from the internal storage or storage card

You can copy your music, photos, and other files to the internal storage or storage card (if one is inserted).

1. Connect HTC Flyer to your computer using the supplied USB cable.
2. On the Connect to PC screen on HTC Flyer, tap **Disk drive**, and then tap **Done**. On your computer, the connected tablet is recognized as a removable disk.
3. Navigate to the internal storage of HTC Flyer or storage card.
4. Do one of the following:
 - Copy the files from the computer to the internal storage of HTC Flyer or storage card's root folder.
 - Copy the files from the internal storage of HTC Flyer or storage card to a folder in your computer.
5. After copying the files, unmount the removable disk (that is, HTC Flyer) as required by your computer's operating system to safely remove HTC Flyer.
6. Do one of the following:
 - Disconnect HTC Flyer from the computer.
 - If you want to keep HTC Flyer connected to the computer but want HTC Flyer to be able to access the internal storage or storage card, open the Notifications panel, tap **Disk drive**, select an option except **Disk drive**, and then tap **Done**.

Copying text, looking up information, and sharing

In applications such as the web browser and Mail, you can select text and choose what you want to do with it.

After selecting text, you can:

- Copy it.
- Search for it using Google Search.
- Look it up on Wikipedia®, YouTube™, or Google Dictionary™.
- Get a translation of the text from Google Translate™.
- Share the text in a new email, text, or multimedia message or in your status update on a social network.

Selecting text

1. Press and hold on a word.
2. Drag the start and end markers to highlight the surrounding text you want to select.



To select text in a link, press and hold the link, and then tap **Copy link URL**.





Copying and pasting text

1. After you have selected the text you want to copy, tap .

The selected text is then copied to the clipboard.
2. In a text entry field (for example while composing a message), press and hold at the point where you want to paste the text.
3. Tap **Paste**.

Searching or translating text

1. After you have selected the text you want to search for or translate, tap .
2. Tap one of the following tabs:

	Google Search Look for related information using Google Search, based on the text that you selected.
	Wikipedia Look for related information on Wikipedia, based on the text that you selected.
	YouTube Look for videos on YouTube, based on the text that you selected.
	Google Translate Translate the text to another language.
	Google Dictionary Look up the selected text in the dictionary.

Pasting text in a new message or social network status update

1. After you have selected the text you want to share, tap .
2. Choose whether to paste the selected text in a new text, multimedia, or email message or in your status update on a social network such as Twitter.



Printing

Connect HTC Flyer to a supported printer and print out documents, email messages, photos, and more.



- Both printer and HTC Flyer must be turned on and connected to the same local network. Connect HTC Flyer to the local network using Wi-Fi. To learn how to connect the printer to a local network, refer to your printer user guide.

- The local network must not be behind a firewall.

1. Open an app such as Mail or Gallery, and then select the file you want to print.
2. Press , and then tap **Print**. In some apps, after pressing , you may need to tap **More** to see **Print**.
3. In the Print screen, tap the printer you want to use.

4. Select the files you want to print at the top of the screen or set the page range you want to print.



Tap **Advanced** to set the page size, print layout, and page orientation, and choose if you want to print in color or black and white.

5. Tap **Print**.

You can check the printing details by opening the Notifications panel, and then tapping the item you're printing.

Personalizing

Making HTC Flyer truly yours

Make HTC Flyer look and sound just the way you want it. Personalize it with a different wallpaper, skin, and notification sound for events such as incoming text, email, and calendar reminders.

Tap the Personalize button  right on the Home screen to get started.

Personalizing HTC Flyer with scenes

Use scenes to create different Home screen arrangements that reflect different aspects of your life. Customize different Home screens for your work, play or travel, and easily switch between them.



Everytime you add or modify something on the Home screen, HTC Flyer automatically saves your changes to the current scene.

Using a preset scene

HTC Flyer features preset scenes, each preconfigured with a different wallpaper and collection of widgets that reflect different moments in your life. You can choose a scene that is suitable for work, play, travel, or your social life.



1. From the Home screen, tap  > **Scene**.
2. Slide your finger on the screen from right to left to select the scene you want.
3. Tap **Apply**.



To download more scenes, tap  > **Scene** > **Get more**.

Creating a new scene



You'll start with an empty Home screen when you create a new scene.

1. From the Home screen, tap  > **Scene**.
2. Press , and then tap **New**.
3. Enter a new scene name, then tap **Done**.
4. Personalize the scene by adding widgets and other elements, arranging the Home screen layout, and changing the skin or wallpaper. All of your changes will be automatically saved to this scene.

Renaming a scene

1. From the Home screen, tap  > **Scene**.
2. Slide your finger on the screen from right to left to select the scene you want to rename.
3. Press and hold a scene thumbnail, then tap **Rename**.
4. Enter a new scene name, then tap **Done**.

Deleting scenes

1. From the Home screen, tap  > **Scene**.
2. Press , and then tap **Delete**.
3. Slide your finger on the screen from right to left to browse through scenes, then tap one or more scenes you want to delete.
4. Tap **Delete**.

Changing your wallpaper

Personalizing your wallpaper with your favorite photo is a quick and easy way to give HTC Flyer a fresh look. Browse the collection of wallpapers included in HTC Flyer or choose from photos that you have taken with the camera. You can also change your Home screen to use an animated wallpaper.

1. From the Home screen, tap  > **Wallpaper**.
2. Tap one of the following:

HTC wallpapers	Choose a preset wallpaper, then tap Preview > Apply .
Live wallpapers	Choose from preset animated wallpapers. Tap Preview to view the animation, and then tap Apply .
Gallery	Choose a photo that you have taken using the camera or copied to your storage card. Crop the photo and then tap Save .



To download more wallpapers, tap  > **Wallpaper** > **HTC wallpapers** > **Get more**.

Applying a new skin

Personalize beyond the Home screen by applying a new skin. Skins are set to give a different look and feel to most onscreen buttons, application screens, option menus, and other items.

1. From the Home screen, tap  > **Skin**.
2. Slide your finger on the screen from right to left to select the skin you want.
3. Tap **Apply**.



To download more skins, tap  > **Skin** > **Get more**.

Personalizing your Home screen with widgets

Widgets put at-a-glance important information and media content up front on your Home screen. Some widgets are already added to your Home screen for your convenience. You can add more from the available selections of widgets.

Adding a widget to your Home screen

1. Go to a part of the Home screen where there's space to add a new widget.
2. Tap  > **Widget**.
3. Select a widget that you want.
4. Most HTC widgets are available in a variety of designs and sizes to suit your needs. Slide your finger on the screen from right to left to view the different styles, and then tap **Select** to choose one.

You can also add widgets that allow you to quickly switch on or off certain settings such as Wi-Fi, Mobile Network, and Bluetooth. Scroll down the widgets list, tap **Settings**, and then tap the widget that you want.



To download more widgets, tap  > **Widget** > **Get more HTC widgets**.

Changing the settings of a widget

You can modify basic settings of some widgets (for example, the People and Mail widgets) from the Home screen.

1. Press and hold a widget on the Home screen. HTC Flyer vibrates and you'll see a colored box around the widget. Don't lift your finger just yet.
2. Drag the widget to the edit button  (if it's enabled).



The relevant screen where you can change some settings for this widget then opens.

3. Customize the widget settings.

Adding icons and other shortcuts on your Home screen



Place app icons on your Home screen to open apps quicker. You can also add shortcuts to settings and specific information such as a bookmarked webpage, someone's phone number, a music playlist, route directions, and many other items, to your Home screen.



The shortcuts available depend on the apps that are installed on HTC Flyer.

1. Go to a part of the Home screen where there's space to add a new icon or shortcut.
2. Tap  and then tap **App** to add an app icon, or **Shortcut** to add a shortcut to a setting or information.



To add an app icon on the Home screen, you can also press , tap , and then press and hold an app icon. Without lifting your finger, drag the icon to an empty area on the Home screen, and then release it.

Adding folders on your Home screen

Use folders to group related apps and other shortcuts to keep your Home screen tidy and organized. You can also add information folders that show up-to-date information such as Bluetooth received files, your Facebook phonebook, and more.

Creating a new folder and adding items to it

1. Go to a part of the Home screen where there's space to add a new folder.
2. Tap  > **Folder**.
3. Tap **New Folder**.
4. Press and hold an app icon or a shortcut that you want to move to the folder. HTC Flyer then vibrates. Don't lift your finger just yet.
5. Drag the app icon or shortcut and drop it on top of the folder.

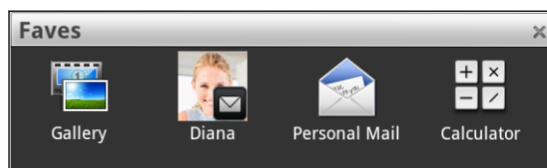

Simply tap the folder to open it so you can access the apps and shortcuts inside the folder.

Renaming a folder

1. Tap the folder to open it.
2. Press and hold the folder window's title bar.
3. Enter a new folder name and then tap **OK**.

Rearranging or removing widgets and icons on your Home screen

Rearrange the widgets and icons on your Home screen to make room for adding more items. You can also remove widgets and icons that you don't frequently use.

Moving a widget or icon

1. Press and hold the widget or icon you want to move. HTC Flyer vibrates and you'll see a colored box around the widget or icon. Don't lift your finger just yet.
2. Drag the widget or icon to a new location on the screen.
 - You can pause at the left or right edge of the screen to drag the widget or icon onto another Home screen panel.
 - When you drag an icon to a spot that's occupied by another icon, the occupant automatically moves away to give room.
3. When the widget or icon is where you want it, lift your finger.

Removing a widget or icon

1. Press and hold the widget or icon you want to remove. HTC Flyer vibrates and you'll see a colored box around the widget or icon. Don't lift your finger just yet.
2. Drag the widget or icon to the remove button .
3. When the widget or icon also turns red, lift your finger.



Customizing the launch bar

You can personalize the launch bar at the bottom of the Home screen and replace it with different apps or shortcuts that you often need to use.

1. Remove an app or shortcut you don't need from the launch bar. Press and hold its icon, and then drag it to the Home screen or to the remove button .
2. Press and hold on the empty slot, and then choose whether to add an app or a shortcut.

Rearranging the Home screen

Reorder your Home screen panels in any way that fits how you use them. For example, move the panels with frequently-used widgets, shortcuts, and folders closer to the main Home screen.



The center thumbnail in Leap view is always the main Home screen.

1. Pinch the Home screen to show the Leap view.
2. Press and hold the thumbnail of the home screen you want to move. HTC Flyer then vibrates. Don't lift your finger just yet.
3. Drag the thumbnail to its new position, and then lift your finger.



Using sound sets

Personalize HTC Flyer to use different sound notifications. By switching between sound sets, you can instantly make HTC Flyer alert you with fun sounds when you're out with friends or change to subtle sounds while you're at work. Each sound set gives you a different combination of sounds for incoming messages, email, calendar event reminders, alarms, and other notifications.

Choosing a preset sound set

1. From the Home screen, tap  > **Sound set**.
2. On the Sound sets screen, tap a sound set name.

3. You can tap  to listen to the different sounds for that sound set.
4. Tap **Apply**.



To download more sound sets, tap  > **Sound set** > **Get more**.

Creating a sound set

1. From the Home screen, tap  > **Sound set**.
2. On the Sound sets screen, tap **New sound set**.
3. Enter a new sound set name, and then tap **Done**.

The newly created sound set is then added to the list of sound sets. You can assign different tones to the sound set to your preference.

Customizing a sound set

Customize a sound set by choosing different sounds for alarms, notifications, new messages, email, and calendar reminders from the preset selection or your storage card (except for notification sounds).

1. From the Home screen, tap  > **Sound set**.
2. Choose a sound set you want to customize or create a new one, and then tap **Apply**.
3. Change the notification sound and alarm from the Personalize screen. Go to the Messages, Mail and Calendar apps to choose sounds for new messages, email, and calendar reminders respectively.

HTC Flyer automatically saves your choices to the current sound set.

Changing notification sounds

1. From the Home screen, tap  > **Notification sound**.
2. Choose the type of notification that you want to change.
3. Tap the sound you want to use. A sample tone briefly plays when selected.
4. Tap **Apply**.





Although you can't import notification sounds from your storage card, you can tap **Get more** to download more audio files from HTC Hub.

Changing the alarm sound

1. From the Home screen, tap  > **Alarm**.
2. Tap the sound you want to use. A sample tone briefly plays when selected.
3. If the audio file is on your storage card, tap **New alarm**, select the item you want to import to the Alarms list, then tap **OK**.
4. Tap **Apply**.

Deleting sound sets

1. From the Home screen, tap  > **Sound set**.
2. Press , and then tap **Delete**.
3. Tap one or more sound sets you want to delete.
4. Tap **Delete**.

Rearranging or hiding application tabs

You can rearrange the tabs at the bottom of some apps to prioritize the types of information you frequently use or remove the tabs you don't really need.

1. Open an app that has the usual tabs at the bottom of its screen (for example, the library screen in Music).



2. Press and hold a tab. When the screen changes and shows you an empty area, lift your finger.
3. Do any of the following:

Move a tab	Press and hold the tab you want to move, and then drag it to its new position.
Remove a tab	Press and hold a tab you want to hide, then drag it up. When you see a colored box, lift your finger.

4. When you're done, press .

Adding a tab back

1. Open the app from which you previously removed some tabs.
2. Press and hold a tab. When the screen changes and shows you some of your hidden tabs, lift your finger.

3. Press and hold the tab you want to show, then drag it down to where you want to position it again.

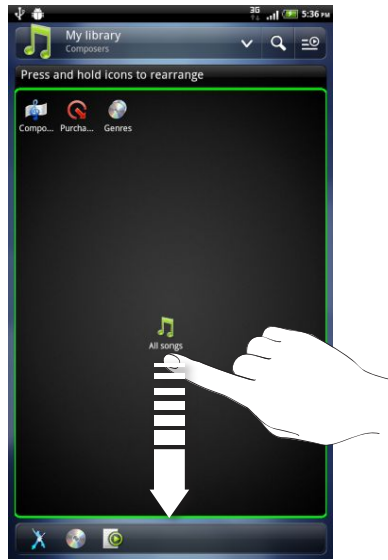

4. When you're done, press .

Search and Web browser

Searching HTC Flyer and the Web

You can search for information on HTC Flyer and on the Web by using Google Search. Some applications, such as People or Mail, have their own search function, which you can use to search only within those applications.

Setting search options



1. From the Home screen, press , and then tap **Settings**.
2. Tap **Search > Google search**.
3. Choose the settings that you want.



Show web suggestions	Display suggestions for Google web searches below the search box as you type.
Use My Location	Include your location in searches to get local search results.
Search history	Use suggestions from the web-based Google search history, from your Google Account. Tap Manage search history to view or manage the web search history associated with your Google Account on the web browser.

4. Press .
5. Tap **Searchable items**, and then select the items you want included when doing a search.

Performing searches on the Web and HTC Flyer



1. From the Home screen, press , and then tap **Search**.
2. Choose where you want to search.

Initially, the Google search box displays the **All** icon , indicating that it's configured to search on both the Web and HTC Flyer. You can target your searches to just the Web only or to just a single application's information on HTC Flyer. Tap  and then tap  to set the searchable items.

3. In the search box, enter the words you want to search for. As you type, matching items on HTC Flyer and suggestions from Google web search are shown as a list.
4. Do one of the following:
 - If what you're searching for is in the list of suggestions, tap it in the list. The item opens in the appropriate application.
 - To edit an item in the list, tap . The item will appear in the search box, where you can edit it.
 - If what you're searching for is not in the list, tap  to search the Web. The web browser opens, displaying the results of a Google search.

Quickly looking up information on the Web



Quick Lookup helps you learn about something right on the spot. When you enter a new word or phrase, you can easily look it up in popular websites or search services such as Google Search and Wikipedia.

1. From the Home screen, tap  > Quick Lookup.
2. If the onscreen keyboard is open, press  to close it first so you'll see the bottom tabs.
3. Slide across the tabs to pick where you want to look up information. Then in the search box, enter what you want to search for.
4. Tap .



After looking up the item on one tab, you can slide to other tabs to automatically look up the same term there.

Translating words to other languages

1. From the Home screen, tap  > Quick Lookup.
2. If the onscreen keyboard is open, press  to close it first so you'll see the bottom tabs.
3. Slide to the Google Translate tab.
4. Under From language, choose the original language, then enter the word or phrase you want to translate.
5. Under To language, choose from the languages available for translation.
6. Tap **Translate**.

Using the web browser



You must have an active data connection or Wi-Fi connection to access the Internet.

Do one of the following to open the web browser and start surfing the Web:

- On the Home screen, tap **Internet**.
- From the Home screen, tap  > **Internet**.

Going to a webpage

1. On the browser screen, tap the URL box on top of the screen.
2. Enter the webpage address using the keyboard. As you enter the address, matching webpage addresses will appear on the screen.
3. Do one of the following:
 - Tap an address to go directly to that webpage.
 - Continue typing in the webpage address, then tap .

Changing the screen orientation

Turn HTC Flyer sideways to display the web browser in landscape orientation.



If the screen orientation doesn't change automatically, turn on automatic screen orientation. From the Home screen, press , tap **Settings** > **Display**, and then select the **Auto-rotate screen** check box.

Navigating and zooming on a webpage

- You can swipe your finger on the screen to navigate and view other areas of the webpage.
- Tap the screen twice quickly to zoom in, then tap the screen twice quickly again to zoom out. You can also use your fingers to spread or pinch the screen to zoom in and out.

Selecting a link on a webpage

You can tap a link to open it, or press and hold a link for more options.

Link	What to do
Webpage address (URLs)	<ul style="list-style-type: none"> ▪ Tap the link to open the webpage. ▪ Press and hold the link to open a menu that allows you to open, bookmark, copy to the clipboard, or share the link.

Link	What to do
Email address	<ul style="list-style-type: none"> ▪ Tap to send an email message to the email address. ▪ Press and hold, then tap Copy on the menu to copy the email address to the clipboard. You can paste the email address later when creating a new contact or sending a new email message.

Opening a new browser window

Open multiple browser windows to make it easier for you to switch from one website to another.



1. While viewing a webpage, tap  to display the Windows pane.
2. Tap .

A new browser window opens to full screen.

Switching between browser windows

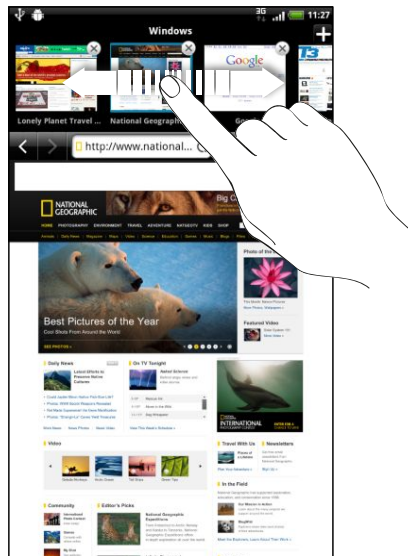
1. On the browser screen, tap  to display the Windows pane.
2. Swipe your finger right or left on the Windows pane to browse through the webpage thumbnails.



3. Tap the thumbnails to quickly switch between the browser windows.
When you tap a thumbnail, the corresponding webpage will be displayed below the Windows pane.
4. Do one of the following:
 - Tap  to close a browser window.
 - To display a webpage in full screen and close the Windows pane, tap .

Downloading from the Web

Do more than just browsing the Web. You can download files such as photos and music as well as apps using the web browser.



- All downloaded files will be saved to the internal storage.
- Before downloading an app, check first its compatibility with HTC Flyer to make sure it can be installed.

Downloading apps from the Web

You can download apps directly from your favorite websites. Apps downloaded from the Web can be from unknown sources. To protect HTC Flyer and your personal data, we strongly recommend that you download and install only apps you trust.

1. Open your web browser, then go to the website where you can download the app you want.
2. Follow the website's instructions for downloading the app.

Before you can install the downloaded app, you need to set HTC Flyer to allow installation of third-party apps. From the Home screen, press , then tap **Settings** > **Applications** > **Unknown sources**.

Viewing your downloads

While viewing a webpage, press  and then tap **More** > **Downloads**.



Viewing bookmarks and previously visited pages

You can store as many bookmarks as you want on HTC Flyer. You can also access a convenient list of the sites you have visited, or quickly view the pages that you access most often.



Bookmarking a webpage

1. While viewing a webpage, tap .
2. To bookmark the web page under a certain category (such as sports or dining), tap **Add tags** and enter a tag name. This groups similar web pages so you can easily locate them.
3. Edit the bookmark name if needed, and then tap **Add**.



Opening a bookmark

1. While viewing a webpage, tap .
2. Do one of the following:
 - On the Bookmarks tab , navigate to the bookmark you want to open, and then tap it.
 - On the Tags tab , open a tag group, navigate to the bookmark you want to open, and then tap it.

Editing a bookmark

1. While viewing a webpage, tap .
2. On the Bookmarks tab , press  and then tap **Edit**.
3. Tap the bookmark you want to edit.
4. Enter your changes, and then tap **Edit**.



Viewing a previously visited page

1. While viewing a webpage, tap .
2. On the History tab , navigate to the page you want to view and then tap the page.



Clearing the list of previously visited pages

1. While viewing a webpage, tap .
2. On the History tab , press , and then tap **Clear history**.

Viewing a page that you often visit

1. While viewing a webpage, tap .
2. On the Most visited tab , navigate to the page you want to view, and then tap the page.

Clearing the list of most visited pages

1. While viewing a webpage, tap .
2. On the Most visited tab , press , and then tap **Clear all**.

Setting browser options

Customize the web browser to suit your browsing lifestyle. Set display, privacy, and security options when using the web browser.

From the browser screen, press , and then tap **More > Settings**.

Setting your home page

1. From the browser screen, press , and then tap **More > Settings > Set home page**.
2. Select the home page you want to use.

Choosing when to show Flash content

Choose which Flash® content you want to see on a webpage, and when you want to view it.

1. From the browser screen, press , and then tap **More > Settings > Enable plugins**.
2. Tap **On demand**.

After selecting **On demand**, you can show the Flash content by tapping  on the webpage.

Tablet pen and fun apps

About the tablet pen

Whether for work or play, we've made something so common yet useful as a pen seamlessly fit your mobile experience. On HTC Flyer, use the tablet pen to take notes, draw pictures, sign contracts, and more.

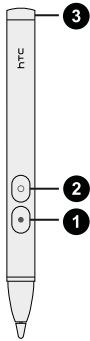

1 HIGHLIGHTER button	Lets you highlight text in pen-integrated apps. For example, highlight your favorite quotes when in Reader.
2 ERASER button	Lets you erase your pen strokes on the current screen.
3 Battery cap	Open the cap when you want to replace the battery of your tablet pen.

Inserting a battery into the tablet pen

Before you start using the tablet pen, you need to first install the disposable AAAA battery that's included in the box. After a period of time, change the tablet pen's battery when you feel that HTC Flyer is not responding too well to your pen strokes.

1. Twist the battery cap counter-clockwise until it detaches from the tablet pen, then remove it completely.

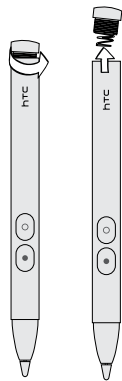

2. With the positive pole first, insert a new battery into the tablet pen.
3. Put the battery cap back into the tablet pen, and then twist it clockwise until it locks in place.

What your tablet pen can do

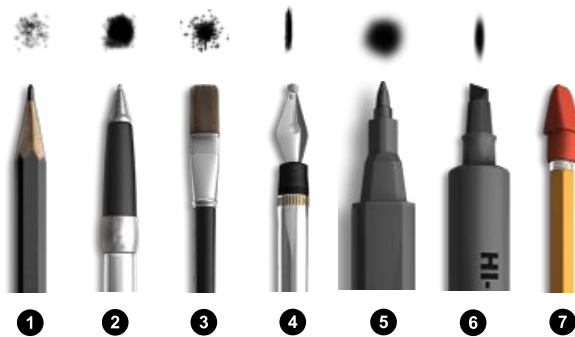

Use the tablet pen to tap the  button on HTC Flyer and open the Pen options palette. This lets you choose from a variety of pen types, strokes, and colors. Here are some of the pens and strokes you can use:



1	Pencil
2	Ballpoint pen
3	Paintbrush
4	Calligraphy pen
5	Marker
6	Highlighter
7	Eraser

How you typically use your regular pen on a piece of paper is also the way you can use the tablet pen on HTC Flyer. In other words, your tablet pen is for:

- **Writing and drawing.**

If  is lighted green, it means that you're in an app where you can freely write and draw. If  is lighted red, then you're in an area where you can't write or draw unless you switch to Scribble mode.

- **Highlighting text.**

When you're reading something interesting in pen-integrated apps, use the tablet pen as a highlighter and mark your favorite words and phrases.

- **Erasing.**

Make quick edits to your notes or sketches.



You still need to use your finger to slide to another screen, scroll through a web page, or select onscreen items in the Home screen and other apps.



Choosing your pen type, color, and stroke



Use your tablet pen (and not your finger) to tap on the  button and any item on the Pen options palette.

1. Open a pen-integrated app. Or if you want to create a note or draw on any app screen or web page, use your tablet pen to tap on the screen to switch to Scribble mode.
2. Tap . This opens a palette where you can customize your pen menu and options. At the bottom, you'll see whether you're in Menu or Options mode.
3. If you're seeing the word **Options** on the Pen options palette, tap on it to switch to Menu mode.





- When in Menu mode, tap any of the following to customize your pen settings:

	Color Tap this button to see the available pen colors. Tap the color you want to use.
	Type Tap this button to see different pen types. Tap a pen to use.
	Stroke Tap this button to see available stroke sizes for the your selected pen type. Tap the stroke size to use.

- Tap  to close the Pen options palette.

While you're using the tablet pen

- While you're writing down notes or scribbling, tap  to open the Pen options palette. At the bottom, you'll see whether you're in Menu or Options mode.
- If you're seeing the word **Menu** on the Pen options palette, tap on it to switch to Options mode.
- When in Options mode, you can then do any of the following:

Undo or redo	Tap  to delete your last pen stroke. Tap  to revert to it again.
Show or hide pen strokes	Tap  to toggle between showing or hiding pen strokes. It's helpful to hide pen strokes at times to view the original page or screen before your edits.
Clear all	Tap  to delete all pen strokes on the current screen.

- You can also press and hold the tablet pen's ERASER button. Don't lift your finger until you're done erasing.

Changing the settings for the tablet pen

From the Home screen, press , and then tap **Settings > Pen**.

Pen history for each app	Select this option if you want HTC Flyer to display recent pen types, strokes, and colors you used in different apps.
Auto launch Scribble mode	Select this option to always switch to Scribble mode every time you tap the tablet pen on the screen (while you're on the Home screen or in an app where you don't normally use the tablet pen).

Highlighting and drawing in pen-integrated apps

Open a document or photo in a pen-integrated app and easily highlight words or draw over it.



Remember that this button  is lighted green on HTC Flyer when you're in an app screen that lets you freely use the tablet pen.

Highlighting text

1. Open any of the following:
 - An eBook in Reader
 - A Word document in Polaris Office
 - A PDF document in PDF Viewer
2. Look for the text you want to highlight.
3. Press and hold the tablet pen's HIGHLIGHTER button, and then highlight the phrase or sentence. Don't release the HIGHLIGHTER button until you're done.



Available pen types depend on the app you're using.

4. To change the highlight color, tap the highlighted text with your finger, and then select a color from the popup menu.



To remove the highlight, tap the highlighted text with your finger, and then tap **Unhighlight**.

Drawing over text

1. Open any of the following:
 - An eBook in Reader
 - A Word document in Polaris Office
 - A PDF document in PDF Viewer
2. Go to the part where you want to place your signature or draw over text.
3. Use the tablet pen to sign or draw.



Available pen types depend on the app you're using.

Drawing over a photo

1. On the Gallery app's Albums screen, tap an album.
2. Tap a photo to view it in full screen.

3. Use the tablet pen to draw over your photo.
4. Press  to apply your changes.



A pen icon appears on the photo thumbnail to indicate that you retouched this photo.



Your pen strokes will be saved as a different layer over the photo so you can remove them anytime. To delete pen strokes, open Gallery, and then view the photo in full screen. Use the tablet pen as an eraser or tap  in the Pen options palette to clear all pen strokes.

You can also send the photo merged with your artwork by email or Bluetooth, or share it to friends in your social networks.

Scribbling

Use the tablet pen to capture app screens as images where you can freely scribble, draw, or mark items. For example, you can switch to Scribble mode while you're reading a web page on HTC Flyer, write down what you think on the same page, and then print or email it to your friends.

1. While you're in an app that supports Scribble mode, just tap any part of the screen with the tablet pen.



Scribble mode is not supported when you're:

- Using an app that lets you freely draw with the tablet pen.
- Playing a video or slideshow in Gallery.
- Reading, playing, or viewing copyrighted materials.
- Framing subjects in the Viewfinder screen of Camera or Camcorder.
- Entering text using the onscreen keyboard.

2. Press when you no longer want to be in Scribble mode. This discards all your scribbles on the current screen.

If you don't want to enter Scribble mode every time you tap the tablet pen on HTC Flyer, press from the Home screen, and then tap **Settings > Pen**. Clear the **Auto launch Scribble mode** check box.

After scribbling

Tap with your finger to select the next action you want for your scribbles.

When you're done scribbling on an app screen, press to show the following options:

Save	Tap to save the clipped screen and your scribbles as an image. When you select this option, your scribbled image is automatically inserted into a page in Notes. You can also view your scribbles in Gallery.
Share via	Tap to send the image to your computer or another device using Bluetooth, send it by email, or select a social network where you want to upload it to.
Print	If you're connected to a printer over Wi-Fi, tap to send the image for printing.
Discard	Tap to delete the image and exit Scribble mode.



You can also tap the screen with your finger to show or hide the Scribble mode options.

About Notes

Seen something inspiring lately? Jot it down in Notes and make it easy to remember your ideas, questions, and everything else. You can write, record audio, attach photos and documents, and even clip your favorite web pages. If you're taking notes during a meeting, you can conveniently link them to the meeting event saved in Calendar.



Create and sign in to your Evernote account from HTC Flyer if you want to back up your notes to Evernote's secure online server. For details, visit www.evernote.com/about/learn_more.

Creating a notebook

1. From the Home screen, tap  > **Notes**.

The first time you open the app, you can take a quick tour and set up your Evernote account. If you choose to skip this, you can later on log in to Evernote in the Accounts & sync settings.

2. On the All notes screen, tap  > **New notebook**.
3. Type in a notebook title.
4. Select a notebook type.
 - Tap **Local notebook** to save this notebook only on HTC Flyer.
 - Tap **Synchronized notebook** to sync your notes with your Evernote account.
5. Tap **Create**.



To open or switch to another notebook, simply tap , then tap a notebook name.

Syncing notes

You can choose whether to automatically or manually sync your notes between HTC Flyer and your Evernote account on the Web.



You need to log in to your Evernote account from HTC Flyer to start syncing notes.



1. From the Home screen, tap  > **Notes**.
2. To manually sync notes, press , and then tap **Sync**.
3. To set Notes to automatically update, press  on the All notes screen, and then tap **More > Settings > Accounts and sync**.
4. Customize your sync settings.

Writing a note

1. From the Home screen, tap  > **Notes**.





If you open the Notes app while you have an ongoing meeting (saved in Calendar), you can associate a note directly with this event.

2. Open a notebook, and then tap .
3. Do any of the following:
 - Tap **Enter title** with your finger, and then type in a note title.
 - Tap on the note to move the text cursor to a page line, then start typing in your text.
4. Use your tablet pen to write, draw over text, highlight, doodle, and more.
5. When done, press , and then tap **Save**.

Adding a photo or attachment to your note

While you have a note open, do any of the following:

Insert a photo

- Move the text cursor to where you want to insert the photo, and then tap  > **Picture** to insert a photo from HTC Flyer.
- Tap  to take a picture.

Attach a document

Tap  > **Document**, and then browse for the document to attach.

Clipping an app screen or a web page

On HTC Flyer, you can clip app screens and web pages as images, and then insert them to your notes.

1. Open the app or web page you want to clip.
2. With the tablet pen, tap any part of the screen to enter Scribble mode.
3. Tap **Save** to add the clipped image into a new note.





If you want to clip web pages without converting them to images, you can sign in and use Evernote on your computer, and then sync your clipped notes with the Notes app. You need to install the Evernote Web Clipper on your computer before you can clip content from the Web. For details, see www.evernote.com.

Taking notes during meetings or discussions

The Notes app lets you capture thoughts, action plans, and meeting minutes better than just writing them down.

While you have a note open, you can:

Create a new note	Tap  .
Record voice clips	Tap  to start and stop audio recording. (You also need to stop recording first when you want to create a new note page.)
Link the note to an event	Tap  , and then select the event to link to in Calendar.

Saving a note

Although the Notes app automatically saves your work when you press , you can still manually save your notes to make sure nothing is lost.

While you have your note open, press , and then tap **Save**.

Reviewing a note



1. From the Home screen, tap  > Notes.
2. Open a notebook, and then tap a note thumbnail.
3. While on the note, you can:



- Slide your finger up or down the screen to scroll the page.
- Tap a file attachment to open it in an appropriate app.
- Tap  to view or change the linked event in Calendar. Or if you haven't linked the note yet, tap to select a calendar event.

Playing an audio recording in Notes

After recording a meeting, you can listen to the audio clip to review key points. If you took notes while audio recording, 'timemarks' (small green nodes in the audio bar) are added to pin your notes within the audio recording's time frame.

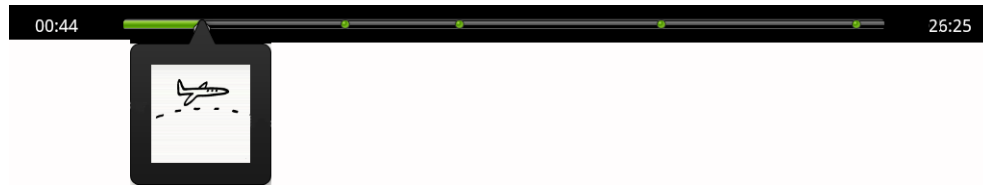

1. Open a note where you have recorded voice clip.
2. Tap  to play the audio recording.
3. Tap  or  to go to the next or previous timemark. When you're moving from one timemark to another, you'll see a note thumbnail for a quick preview of what you noted down while recording.



You can also tap a particular content on your note to jump to its timemark and hear the audio you've recorded at that time.

Sharing a note

You can send your notes by email or Bluetooth, or share them with friends in your social networks.



1. From the Home screen, tap  > **Notes**.
2. Open a notebook, and then tap the note to share.
3. Press , and then tap **Share note**.
4. Choose how you want to share your note.



- For most sharing options, notes are automatically converted and sent as images.
- You can print notes when HTC Flyer is connected to a printer over Wi-Fi.

Sketching



Unleash the artist in you and create your own sketch portfolio. While you're at it, you can also record your tablet pen strokes and add your voice-over.

1. From the Home screen, tap  > **Sketchbook**.
2. On the All sketches screen, tap .
3. Tap **Enter title**, and then type in a title for your sketch. Press  to close the onscreen keyboard.
4. Tap the blank sketch pad with your finger when you're ready to start.



- Use your tablet pen to sketch a character, design, or doodle.



Your pen strokes and audio will automatically be recorded. If you don't want to record a voice-over, tap .

- To stop recording, tap the sketch pad with your finger to show the onscreen controls, and then . You can tap  again to resume recording.
- When you're done sketching, press  to save and close your sketch.

Playing back a recorded sketch demo

- From the Home screen, tap  > Sketchbook.
- On the All sketches screen, tap a sketch thumbnail to open it.
- Tap .





If you don't see the play button, tap the sketch pad with your finger to show the onscreen controls.

- To pause or stop your sketch demo, tap  or .

Sharing your sketches

You can send image files of your sketches by email or Bluetooth, or share them with friends in your social networks.

1. From the Home screen, tap  > Sketchbook.
2. Do one of the following:



Share multiple sketches	On the All sketches screen, tap  , then choose how you want to share your sketches. Select one or more items, and then tap Next .
Share a sketch	On the All sketches screen, tap a sketch thumbnail to open it. Tap  in the onscreen control bar, and then choose how you want to share your sketch.



You can also print your sketches when HTC Flyer is connected to a printer over Wi-Fi. While viewing a sketch, press , and then tap **Print**.

Managing your sketches



Renaming a sketch

1. From the Home screen, tap  > Sketchbook.
2. On the All sketches screen, tap a sketch thumbnail to open it.
3. Press , and then tap **Rename**.
4. Tap **Enter title**, and then type in a new title for your sketch.
5. Tap the sketch pad to save the new title and close the onscreen keyboard.



Searching for a sketch

1. On the All sketches screen, tap .
2. Enter the sketch title to search. As you type, matching items are shown in a list.
3. Tap an item to open it.

Sorting your sketches

1. From the Home screen, tap  > Sketchbook.
2. On the All sketches screen, press , and then tap **Sort**.
3. Select one of the sorting order options.

Deleting sketches

1. From the Home screen, tap  > Sketchbook.
2. On the All sketches screen, press , and then tap **Delete**.
3. Select one or more items to remove, and then tap **Delete**.

Switching to Kid Mode

Afraid that your kids might wander off to inappropriate web sites or your important work files while using HTC Flyer? Don't worry. Open Kid Mode and let your children enjoy fun games, art, and books that are right for their age.



To learn more about Kid Mode, visit www.zoodles.com.

To use this app, you need to:

- Connect to the Internet (using a data or Wi-Fi connection)
- Create or sign in to your Zoodles™ account

From the Home screen, tap  > Kid Mode.

Setting your Zoodles Kid Mode options

1. From the Home screen, tap  > Kid Mode.
2. On the Zoodles main screen, press , and then tap **Settings**.



To return to the Zoodles main screen, tap  on the upper left corner of the app.

3. With your finger, confirm the action by drawing the letter Z on the screen.
4. Under Device options, do any of the following:

Lock Home Button	Select this option to disable  while in Kid Mode.
Data Over 3G/4G	Select if it's OK to use data connection for playing games and doing other activities from Zoodles. Clear this option if you only want to use a Wi-Fi connection for this app.
High-quality Video	Tap to choose whether to play high-quality videos always or just when you're connected to Wi-Fi. Selecting Always may incur additional fees from your mobile operator.

Startup Volume	Set the volume level for the app's startup sound.
Maximum Volume	Set the maximum volume limit to use for this app.

5. Press  to return to the Zoodles main screen.

Closing Kid Mode

Press  twice, and then confirm your action by drawing the letter Z with your finger.

Snapbooth and Camera

Snapbooth

Using Snapbooth

Have fun taking closeup shots of yourself or with your loved ones using Snapbooth. Choose from virtual lenses or add effects to make moments memorable. You can also choose to take a composite photo with four different shots.

Taking your closeup shot

1. From the Home screen, tap  > Snapbooth.
2. Choose how you want to take your photo.



In **One shot** mode, the front camera takes a single shot.



In **Four shots** mode, the front camera takes four shots and combines them into a single photo.

3. Choose an effect to apply to your photo.
4. Hold HTC Flyer in portrait or landscape position with both hands, and then adjust or move it to center yourself inside the Viewfinder window.
5. When you're ready to take your photo, look at the front camera lens, and then tap .



Snapbooth counts down before taking the shot. To cancel the shot, tap .

After taking your photo, you can choose to share it or just delete it if you want to take another shot.

Your photo is then displayed as a thumbnail on the screen. Tap the thumbnail to view it in full screen or edit it.



You can use Gallery to view the photos you've taken. Go to the **Snapbooth** album in Gallery to view them.

Viewing or editing a photo in full screen

- While viewing a photo in full screen, swipe your finger left or right across the screen to go through the other photos you've taken.
- Tap anywhere on the screen and then choose what to do with the current photo.

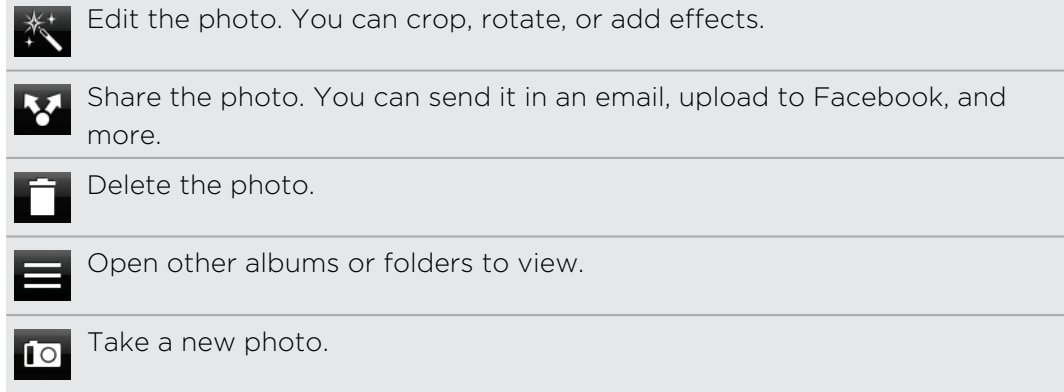

- You can also zoom in or out of a photo.



Camera

Camera basics

Whether traveling for business or fun, enjoy taking photos and videos of your trip and encounters with HTC Flyer.



Be sure to plug in your storage card before you start. Photos and videos captured with the camera will be stored onto your storage card.

- To open the camera in photo mode and take photos, tap  from the Home screen, and then tap **Camera**.
- To open the camera directly in video mode so you can immediately start capturing videos, tap  from the Home screen, and then tap **Camcorder**.

Viewfinder screen

You'll find the following onscreen controls on the Viewfinder screen:



	Zoom bar
	Auto focus indicator
	Photo/Video mode switch
	Shutter release/Record button
	Effects button
	Gallery button
	Switch to front or main camera button

Zooming

Before taking a photo or video, you can first use the onscreen zoom bar to zoom in or out of your subject.

Simply slide your finger up or down the zoom bar to zoom in or out.



When you're recording video, the zoom bar is always shown onscreen. You can freely zoom in or out while recording.

Auto focusing

Whenever you point the camera at a different subject or location, it shows the auto focus indicator at the center of the Viewfinder screen.

Let the camera auto focus on the center of the screen. Or you can tap another area on the screen that you want to focus on.

Using the front camera

Take a picture or shoot a video of yourself using the front camera.

To switch to the front camera, on the camera screen, tap or . To switch back to the main camera, tap or again.



Some camera features are not available when you're using the front camera, such as auto focusing, zooming, and face detection.

Taking a photo

1. From the Home screen, tap  > **Camera**.
2. Before taking the photo, you can zoom in or out first on your subject.
3. Choose the resolution and other camera settings you want to use.
4. Choose an effect to apply to your photo.
5. Point the camera and focus on your subject.

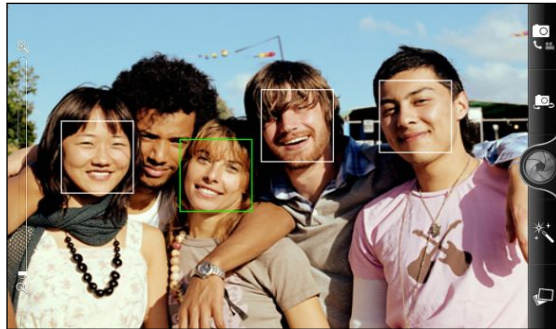

If you're taking people's photo, the camera will automatically recognize faces and adjust the focus. You'll see boxes on people's faces.



Make sure the **Auto focus** and **Face detection** check boxes are selected in the camera settings.

6. When you're ready to take the photo, tap .
7. Choose what you want to do with the photo you've just taken.

Recording video

1. From the Home screen, tap  > **Camcorder**.
2. Choose the video quality and other camera settings you want to use.
3. Choose an effect to apply to your video.
4. Frame your subject on the Viewfinder screen.
5. Tap  to start recording.
6. You can freely zoom in or out while recording video.
7. You can change focus to a different subject or area by just tapping it on the Viewfinder screen.
8. To stop recording, tap  again.
9. Choose what you want to do with the video you've just recorded.

Adding effects

Want to make your photos look more interesting? Easy. Use the available camera effects to make your photos look like they've been taken through special lenses and filters. You can also add certain effects to videos.





Choose an effect first before you start taking a photo or video.

1. Tap .
2. Scroll through the available effects and tap one that you like.

When you choose certain photo effects such as depth of field, distortion, or vignette, drag the bar that appears on the screen to adjust the intensity of the effect.

After capturing

After capturing a photo or video, the Review screen will display the photo or the starting image of the video that you have just captured. Tap the onscreen buttons to choose what you want to do next.

	Return to the Viewfinder screen.
	Delete the photo or video
	Send the photo or video to your computer or another device using Bluetooth, send it by email, or select a social network where you want to upload it to.
	Choose how you want to use the photo, such as to use it as your wallpaper
	Watch the video.

Changing camera settings

Open the menu panel to access and change camera settings.

To open the camera settings, press .



Some camera features are not available when you're using the front camera, such as auto focusing, zooming, and face detection.

Self-timer (photo mode only)	Set a time delay before your camera automatically takes the photo.
Image adjustments	Slide your finger across each of the slider bars to adjust the exposure, contrast, saturation, and sharpness.
White balance	White balance enables the camera to capture colors more accurately by adjusting to your current lighting environment.

Resolution/Video quality	Choose a photo or video resolution to use.
ISO (photo mode only)	Choose an ISO level or set it back to Auto . Higher ISO numbers are better for taking pictures in low light conditions.
Review duration	Set the time for a captured photo or video to be displayed on the Review screen before the camera changes back to the Viewfinder screen.
Widescreen (photo mode only)	When this check box is selected (default), photo resolutions available for selection are in 16:9 ratio and you can use the entire Viewfinder screen to frame your subject. When not selected, photo resolutions available for selection are in standard 4:3 ratio.
Geo-tag photos (photo mode only)	Select to store GPS location in your captured photos.
Mirror mode (front camera only)	Select to show the mirror image on the viewfinder screen.
Auto enhance (photo mode only)	Select to reduce noise when using a high ISO setting and to automatically adjust photo brightness.
Auto focus (photo mode only)	Enables or disables centered auto focus.
Face detection (photo mode only)	Select to automatically recognize faces and adjust the focus when you take people photos. Face detection will be turned off if you disable auto focus.
Shutter sound	Select to play a sound when you press the shutter release or record button.
Grid (photo mode only)	Select to display a grid on the Viewfinder screen so you can easily frame and center your subject before taking the photo.
Record with audio (video mode only)	Select to record audio when capturing videos.
Reset to default	Change the camera settings back to default.

Photos, videos, and music

Gallery

About the Gallery app

Relive the fun while viewing photos and videos of your latest travels or your pet's newest tricks. Get an audience by tagging your Facebook and Flickr friends. You can even play your media on a TV screen.



To start using Gallery, check first if you have photos or videos copied to the internal storage.

What's more, you can edit and add effects to your photos. You can also easily use a photo as your contact icon, location icon, or wallpaper.

Selecting an album

From the Home screen, tap  > **Gallery**. The Gallery app opens on the Albums screen where your photos and videos are organized by albums for easy viewing.



Turn HTC Flyer to the left to see your albums and thumbnail previews of the albums' content side-by-side.



The following are preset albums:

- **Camera shots** lets you view photos and videos that are stored in the camera's folder.
- **My favorites** lets you group photos and videos that you set as your favorites.
- **All photos** lets you view all photos that are stored in all the folders on the internal storage.
- **All videos** lets you view all videos that are stored in all the folders on the internal storage.
- **All downloads** lets you view photos and videos that you downloaded.
- **Snapbooth** lets you view all photos you've taken using Snapbooth.

Folders in the internal storage that contain photos and videos will also be treated as albums and will be listed after the preset albums. The actual folder names will be used as the album names.



- If there are photos or videos under the root path of the internal storage (that are not contained in folders), they will be grouped under the **Other** album.
- If you've inserted a storage card into HTC Flyer, the photos and videos in the storage card will show as well.

Viewing photos

After you've selected an album, you can browse through your photos and videos.

Slide your finger up or down to scroll through the thumbnails. Tap a photo or video to view it in full screen.



Zooming in or out on a photo

There are two ways you can zoom in or out of a photo.

- Tap the screen twice quickly to zoom in, then tap the screen twice quickly again to zoom out.
- Press your thumb and index finger on the screen and then spread your fingers apart to zoom in; pinch your fingers together to zoom out.

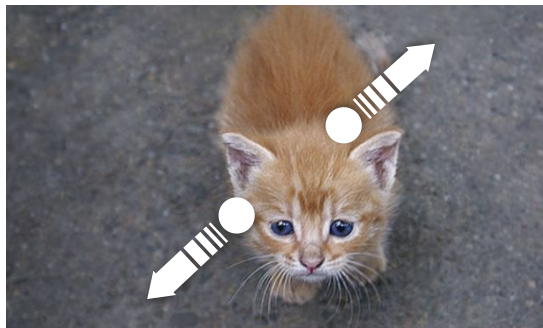

Viewing photos as a slideshow

View the photos in an album as a slideshow.

1. Select an album whose photos you want to view as a slideshow.
2. Tap .



- Tap the screen to show the playback controls.
- With the playback controls showing, tap  to set slideshow preferences.

Watching videos



While browsing an album, tap a video to play it.



Another way to easily get to your videos is to tap  from the Homescreen, and then tap **Videos**.

- Use the onscreen controls to play, pause, or stop the video.



- For an enhanced audio experience, tap  to turn on SRS. (Not available when you're using a Bluetooth headset.)
- Tap  to toggle between full and best-fit screens.

Editing your photos

Do basic editing tasks on your photos such as rotate and crop. You can also enhance your photos by applying effects such as high contrast, vintage, and more.

Rotating a photo

1. On the Gallery app's Albums screen, tap an album.
2. Press and hold on the photo that you want to rotate.
3. In the menu that opens, tap **Edit**, and then tap either **Rotate left** or **Rotate right**.

Cropping a photo

1. On the Gallery app's Albums screen, tap an album.
2. Press and hold on the photo that you want to crop.

3. In the menu that opens, tap **Edit**, and then tap **Crop**. You'll see a crop box around the photo.
4. To adjust the crop box size, press and hold the edge of the box.



5. When directional arrows appear, drag your finger inward or outward to resize the crop box.
6. To move the crop box to the part of the photo that you want to crop, drag the crop box to the desired position.
7. Tap **Save** to keep the changes.

The cropped photo is saved as a copy. The original photo remains unedited.

Adding effects

1. On the Gallery app's Albums screen, tap an album.
2. Press and hold on the photo that you want to add effects to.
3. In the menu that opens, tap **Edit**, and then tap **Effects**. On the panel that opens, you'll see options available to you.
4. Tap an effect to apply on the photo.
5. Tap **Save** to keep the changes.



The enhanced photo is saved as a copy. The original photo remains unedited.

Sending your photos and videos

Send photos and videos via email or MMS to your computer or another device using Bluetooth.

Sending photos or videos by email

You can send several photos, videos, or both in an email message. They are added as file attachments in your email.



1. From the Home screen, tap  > **Gallery**.
2. Tap the album that has the photos or videos you want to share.
3. Tap  and then tap **Gmail** or **Mail**.

4. Select the photos or videos you want to share and then tap **Next**.
5. Compose your message and then tap  (Gmail) or **Send** (Mail).





If you selected **Mail** and you have multiple email accounts, the default email account will be used.

Sending a photo or video by MMS

1. From the Home screen, tap  > **Gallery**.
2. Tap the album that has the photos or videos you want to share.
3. Tap  and then tap **Messages**.
4. Tap the photo or video you want to send. The photo or video is automatically added into the MMS message.
5. To add another photo or video to your slideshow attachment, tap  and then tap **Picture** or **Video**.
6. Compose your message and then tap **Send**.

Sending photos or videos using Bluetooth

You can select several photos, videos, or both and send them to someone's device or your computer using Bluetooth.

1. From the Home screen, tap  > **Gallery**.
2. Tap the album that has the photos or videos you want to share.
3. Tap  and then tap **Bluetooth**.
4. Select the photos or videos you want to share and then tap **Next**.

In the next few steps, you'll be asked to turn on Bluetooth on HTC Flyer and connect to the receiving Bluetooth device so the files can be sent.

Sharing your photos and videos on the Web

Using the Gallery app, you can share photos and videos on your social networks, as well as post videos on YouTube.





You can also use the Camera or Camcorder app to share a photo or video right after you've captured it.

Sharing photos or videos on Facebook



You need to be logged in to your account to be able to upload photos or videos.



1. From the Home screen, tap  > **Gallery**.
2. Tap the album that has the photos or videos you want to share.
3. Tap  and then tap **Facebook for HTC Sense**.
4. Select the photos or videos you want to share and then tap **Next**.

5. Enter a different caption on each photo or video. You can also tag friends on your photos. Tap **Tap to add tag**, and then tap the part where your friend is. From the list that shows, select who you want to tag.
6. Slide to the left to go to the next photo or video.
7. Tap **Upload**.
8. Select which album to upload to and set privacy settings for the uploaded photos or videos.
9. Tap **Done**.

Sharing photos and videos on Flickr





You need to be logged in to your Flickr account to be able to upload photos or videos.

1. From the Home screen, tap  > **Gallery**.
2. Tap the album that has the photos or videos you want to share.
3. Tap  and then tap **Flickr**.
4. Select the photos or videos you want to share and then tap **Next**.
5. Enter a different title and description on each photo or video. You can also tag friends on your photos. Tap **Tap to add tag**, and then tap the part where your friend is. From the list that shows, select who you want to tag.
6. Slide to the left to go to the next photo or video.
7. Tap **Upload**.
8. Select which album to upload to and set privacy settings for the uploaded photos or videos.
9. Tap **Done**.

Sharing photos on Picasa





You need to be signed in to a Google Account to be able to upload photos to the Picasa photo organizing service.

1. From the Home screen, tap  > **Gallery**.
2. Tap the album that has the photos you want to share.
3. Tap  and then tap **Picasa**.
4. Select the photos you want to share and then tap **Next**.
5. Enter a caption for the photos you're uploading.
6. Select the online album where you want to upload the photos, or tap  to create a new album.
7. Tap **Upload**.

You can view the photos online at <http://picasaweb.google.com>.

Sharing videos on YouTube

You can share your videos by uploading them to YouTube.

1. From the Home screen, tap  > **Gallery**.
2. Tap the album that has the videos you want to share.
3. Tap  and then tap **YouTube**.
4. Select the videos you want to share and then tap **Next**. Sign in to your YouTube or Google Account, if you're asked to do so.
5. Enter a title for the videos you're uploading.
6. Tap **More details** where you can enter information such as description and tags, and select a privacy option.
7. Tap **Upload**.

Viewing photos in your social networks

Right in the Gallery app, check what you and your friends have uploaded to your social networks (Facebook and Flickr only).

Viewing photos on Facebook

You need to be logged in to your Facebook account to view Facebook photos.

1. From the Home screen, tap  > **Gallery**.
2. On the top of the screen, tap the bar that displays the current view (for example, **Albums**), and then tap **Facebook**.

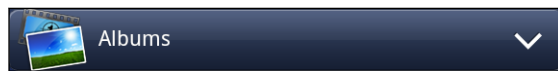

3. Tap your account name or your friend's account on the list to view the photos in the account.

You can view photos in your online albums in the same way as you view photos in Gallery.

Viewing photos on Flickr

You need to be logged in to your Flickr account to view Flickr photos.

1. From the Home screen, tap  > **Gallery**.
2. On the top of the screen, tap the bar that displays the current view (for example, **Albums**), and then tap **Flickr**.

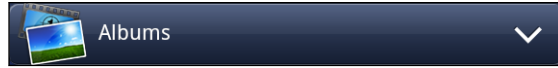

You may be asked to give authorization for the app to connect to the Flickr website. If this happens, you need to give authorization to access your Flickr account.

3. Tap your account name or your friend's account on the list to view the photos in the account.

You can view photos in your online albums in the same way as you view photos in Gallery.

Commenting on photos in your social networks

Add comments to your uploaded photos as well as your friends' photos.

1. Do one of the following:
 - While browsing online albums, press and hold a photo and then tap **Add comment**.
 - While viewing a photo in full screen, tap anywhere on the screen, and then tap .
2. Tap the box that says "Write a comment."
3. Enter your text, and then tap **Comment**.

Music

Listening to music



Enjoy listening to songs and music on HTC Flyer using the Music app.



You need to copy music files to the internal storage first (or an inserted storage card) to use the Music app to play music.

1. From the Home screen, tap  > **Music**.
2. In the playback screen, swipe your finger left or right across the screen to go to the next or previous music album.



If you're not in the playback screen, tap  or .

3. Tap the onscreen icons to control music playback, select a song to play, repeat songs, and more.

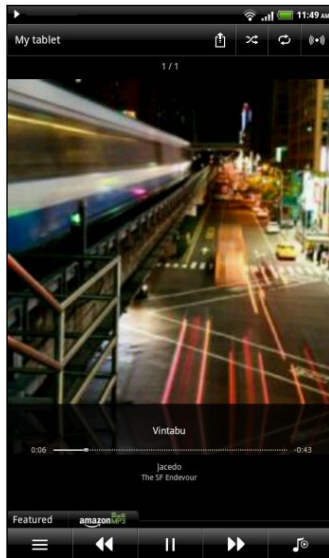

Tap to share music on your home network.



Turn shuffle on or off. (Shuffle is off when button is gray.)



Cycle through the repeat modes: repeat all songs, repeat current song, and don't repeat.



Enjoy listening to your music with SRS. Or, if you're using a wired headset, you can also choose from various preset equalizer settings. (SRS and equalizer are not available when you're using a Bluetooth stereo headset.)



Press and drag your finger across the progress bar to jump to any part of the song.



Tap to check out featured albums from HTCSense.com. (Availability depends on your country.)



Go to the library.



Switch between showing the Now playing list and playback screen. You can rearrange songs in the Now playing list.

Playing music from the Lock screen

When you're listening to music and the screen turns off, press POWER to turn the screen back on and control the music playback directly on the Lock screen.

If you don't see the playback controls on the Lock screen, swipe your finger from left to right on the box onscreen.



You can also pause music playback right from the Notifications panel.

Browsing and playing music in landscape view

Turn HTC Flyer to the left to switch to landscape view. In landscape view, you can see the library and the playback screen or Now playing list side-by-side making it easier for you to browse and play your music at the same time.

In landscape view, tap  to let you skim through your albums easily.

- If you have lots of albums, flick left or right across the screen to quickly skim through them.
- Tap an album to see the song list of the current album.

About the Music widget

You can use the Music widget to play music right from your Home screen.

Browsing music in the library



1. Tap  on the Music app's playback screen or Now playing list to go to the library. In the library, your music is organized by categories such as Artists and Albums. Choose a category by tapping one of the tabs at the bottom of the screen.
2. Tap a song in a category to play it. The Now playing list is updated with the song list from your selected category.



You can add, remove, or rearrange the tabs in the library.

Creating a playlist

Personalize your music experience by creating music playlists. Make a playlist containing just your favorite songs or create one to match your mood for the day. You can make as many playlists as you like.

1. From the Home screen, tap  > Music.
2. Tap  to go to the library.
3. In the library, tap or slide your finger on the bottom row to go to the **Playlists** category.
4. On the upper-right corner of the screen, tap .
5. Enter a playlist name, and then tap **Add songs to playlist**.
6. Choose a category.
7. Select the check boxes of songs you want to add to the playlist and then tap **Add**.
8. Tap **Save**.

Playing the songs in a playlist

1. In the library, tap or slide your finger on the bottom row to go to the **Playlists** category.
2. Tap a playlist to open it.
3. Tap the first song or any song in the playlist.

When you tap a song in the list to play it, the playback screen is updated with the songs from your playlist.

Managing playlists

After creating a playlist, you can add more songs to it, rearrange their order, and more.

1. In the library, tap or slide your finger on the bottom row to go to the **Playlists** category.
2. Tap a playlist to open it.
3. Press , and then choose what you want to do:



Add more songs to a playlist	<ol style="list-style-type: none"> 1. Tap Add songs. 2. Go to the Songs category or any other category. 3. Select the songs you want to add to the playlist and then tap Add.
Rearrange songs	<ol style="list-style-type: none"> 1. Tap Change order. 2. Press and hold  at the end of the song title you want to move. When the row is highlighted, drag it to its new position, then release.
Delete songs from a playlist	<ol style="list-style-type: none"> 1. Tap Remove songs. 2. Select the songs you want to delete and then tap Remove.
Change playlist name	Tap Rename playlist .

Deleting playlists

1. In the library, tap or slide your finger on the bottom row to go to the **Playlists** category.
2. Press  and then tap **Delete playlists**.
3. Select the playlists to delete and then tap **Delete**.

Sharing music using Bluetooth

You can choose a song from the Music app's library and send it to someone's phone or your computer using Bluetooth.

1. From the Home screen, tap  > **Music**.
2. Tap  to go to the library.

3. In the library, choose the song that you want to send via Bluetooth and then play it back.
4. On the playback screen, press  and then tap **Share > Bluetooth**.

In the next few steps, you'll be asked to turn on Bluetooth on HTC Flyer and connect to the receiving Bluetooth device so the music can be sent.

Finding music videos on YouTube

You can find music videos of the song you're listening to on YouTube. It's simple. On the playback screen, just press  and then tap **Find videos**.

Connected Media

Sharing media on your home network

Sharing photos, videos, and music with a bigger circle of friends is easy on your home network. Simply connect HTC Flyer to the network and instantly show your captured photos and videos on a big TV, or start streaming your favorite music tracks on hi-fi speakers — all via DLNA®. For more information about DLNA, visit www.dlna.org.

Before you share media through the network:

- Connect HTC Flyer to the network via Wi-Fi.
- Connect the TV or speakers to the network. Check the documentation that came with your TV or speakers to know how.

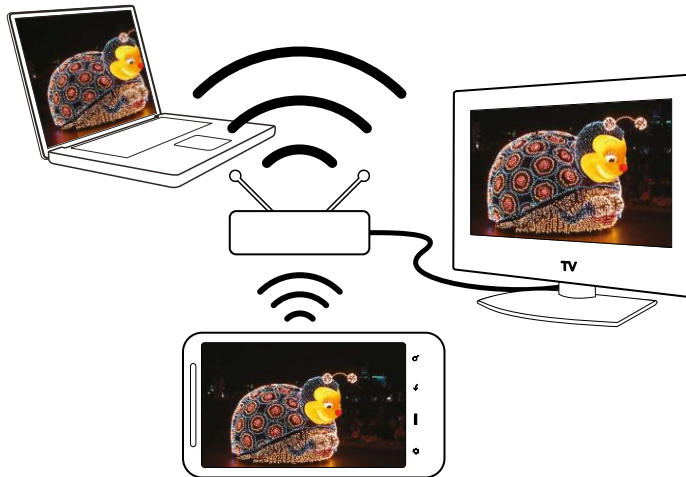











1. Open the Gallery or Music app.
2. Locate the media that you want to share, and then tap it.
3. While viewing the photo or playing the video, press , and then tap **Select player** or **More > Select player** if you're playing music.



When playing music, you can also tap .

4. Choose the device on your network where you want to play the media.
5. Once connected to the other device, HTC Flyer opens up the Controller screen where you can tap:

Controls	To
	Play the media on the other device.
	Pause the music or video playback.
	Play the previous photo or music track.
	Play the next photo or music track.
	Shuffle your music playlist.
	Select a repeat mode for photos or music tracks.
	Show available media that you can share.
	When playing music, tap to turn on SRS.
	When playing music, tap to switch to the Now playing list.
	Connect to another player on the network.



While playing a media on another device, you can press  and do other things on HTC Flyer. To return to the Controller screen, slide open the Notifications panel, and then tap the device you're connected to.

HTC services

HTC Watch

Watch trailers of upcoming movies with the HTC Watch Lite version. The full version of HTC Watch, which also allows you to download and purchase movies, will be available soon. Check for software updates from time to time on HTC Flyer to get the full version of HTC Watch.

Signing up for your HTCSense.com account

You can sign up for your HTCSense.com account on HTC Flyer or your computer's web browser.

Signing up from HTC Flyer

1. From the Home screen, press , and then tap **Settings > Accounts & sync**.
2. Tap **Add account > HTC Sense**.
3. Follow the onscreen instructions to sign up for your HTCSense.com account.

Signing up from your computer

Make sure you have HTC Flyer close by. You'll need it to complete the sign-up process.

1. On your computer, open your web browser.
2. Go to www.htcsense.com.
3. Follow the onscreen instructions to sign up for your HTCSense.com account.

After signing up to HTCSense.com on the Web, you have to sign in using the same account credentials on HTC Flyer.

Updating your HTCSense.com account details

1. On your computer, open your web browser and sign in to your HTCSense.com account.
2. On the upper-right corner, click **Account**.
3. Update your account details, and then click **Save Changes**.

Using HTCSense.com

Forgot HTC Flyer at home or you can't find it? Or worse, you forgot it on the train. Use HTCSense.com to communicate with HTC Flyer so you can forward messages to a different number, make HTC Flyer ring, lock it, and even erase its contents.

To use these features, you'll need to sign in to HTCSense.com on a computer web browser.

Turning on Device finder

Some features of HTCSense.com require that the Device finder option on HTC Flyer is selected.

1. On HTC Flyer, from the Home screen, press , and then tap **Settings**.
2. Tap **Location**.
3. Select the **Device finder** check box.

Forwarding messages

You can forward messages to another phone if you don't have HTC Flyer with you.

On the HTCSense.com, click the **Forward messages** On/Off switch.

Making HTC Flyer ring

You know HTC Flyer is somewhere in your home but you just can't find it. Make HTC Flyer ring, even if it's on mute, so that you can find it. Hopefully, it's just buried under some clothes in the hamper.

On HTCSense.com, click **Ring**.

Locating HTC Flyer

Left HTC Flyer somewhere while doing your errands? You can use HTCSense.com to find its approximate location.



You must have the **Device finder** option selected on HTC Flyer for this feature to work.

On HTCSense.com, check the map to see where HTC Flyer is. Click **Refresh location** to refresh the map.

Locking HTC Flyer

Lost HTC Flyer? Lock HTC Flyer and show a message onscreen.

1. On HTCSense.com, click **Lock device**.
2. Enter a PIN and a short message to show onscreen.
3. Click **Save**.

Erasing the contents of HTC Flyer

If there's no chance of getting HTC Flyer back, you can erase the contents of HTC Flyer and the installed storage card so no one sees sensitive information on HTC Flyer.



There's no way to recover HTC Flyer and storage card data after you erase the contents so be absolutely sure before you proceed.

1. On HTCSense.com, click **Erase device**.
2. When asked to confirm, click **Erase device**.

Deleting your HTCSense.com account

1. On your computer, open your web browser and sign in to your HTCSense.com account.
2. On the upper-right corner, click **Account**.
3. Click **Click here to delete your HTCSense account**.

Deleting your HTCSense.com account will also delete your data on HTCSense.com servers.

Accounts and sync

About online accounts

HTC Flyer can sync with popular online social networking and email accounts.

The information you can get includes:

- Gmail, Exchange ActiveSync®, and other POP3/IMAP email.
- Google and Exchange ActiveSync contacts, as well as your friends' contact information in Facebook and their Twitter profiles.
- Calendar events from your Google Account(s), from Exchange ActiveSync, and from your Facebook account.
- Status updates and links shared by your friends and yourself on social networks such as Facebook and Twitter.
- Flickr and Facebook photo uploads.



You can set up your Exchange ActiveSync and POP3/IMAP email accounts on HTC Flyer either in the Mail app or the Accounts & sync settings.

Synchronizing with a Google Account

Signing in to your Google Account lets you sync Gmail and your Google contacts and calendars between HTC Flyer and the Web. You also need to sign in to a Google Account to use Google apps such as Google Talk™ and Android Market.



If you skipped adding a Google Account when you first set up HTC Flyer, you may encounter problems when using some Google apps. If these problems persist, you may need to factory reset HTC Flyer and enter your Google Account details when you set up HTC Flyer again.

Adding more Google Accounts

You can add more than one Google Account. However, subsequent Google Accounts can only sync contacts, emails, and calendar events. Other Google services use the first Google Account you added.

1. From the Home screen, press , and then tap **Settings > Accounts & sync**.
2. Tap **Add account > Google**.
3. Follow the onscreen instructions to sign in to an account or create a new account.

Forgot your Google Account password?

If you have forgotten your Google Account password, you can try to recover it by going to the Google website.

1. On HTC Flyer or on your computer, open your web browser and go to <https://www.google.com/accounts/ForgotPasswd>.
2. Enter the email address or username that you use to sign in to your Google Account and click **Submit**.
3. Follow the instructions on the screen to reset your password.

If you don't have an alternate email address or cannot access the email account you used to create your Google Account, you can reset your Google Account after 24 hours by answering the security question for password recovery.

Adding a social network account

Skipped signing in to your social network accounts (such as Facebook, Twitter, or Flickr) when you first turned on and set up HTC Flyer? You can still add these accounts.

1. From the Home screen, press , and then tap **Settings > Accounts & sync**.
2. Tap **Add account**, and then tap the account type you want to add.
3. Follow the onscreen instructions to enter the account information.

Your social network account is then added to the list on the Accounts & sync screen. Depending on how you configured the account, the new information may start synchronizing with HTC Flyer.

Managing your online accounts

Changing general sync settings

1. From the Home screen, press , and then tap **Settings > Accounts & sync**.
2. Select or clear the following:

Background data	If this is selected, apps can send and receive online account information even if you are not currently using them.
Auto-sync	If this is selected, apps can use the sync schedule defined in the account settings. If this is cleared, you will need to sync accounts manually.

Synchronizing an account manually

1. From the Home screen, press , and then tap **Settings > Accounts & sync**.
2. Tap the account that you want to sync.
3. Tap **Sync now**.

Changing account settings

You can change settings such as the sync frequency and the types of information synchronized, the kinds of notification you receive, and the way that account information is displayed.

1. From the Home screen, press , and then tap **Settings > Accounts & sync**.
2. On the Accounts & sync screen, tap the account that you want to edit.
3. Tap the type of information you want to sync or select an item to edit its settings.

Removing an account

You can remove an account to delete it and all information associated with it from HTC Flyer, for example messages, contacts, or settings. Removing an account does not delete information from the online service itself.



You cannot remove some accounts, such as the first Google account you signed into, except by deleting all personal information from HTC Flyer with a hard reset.

1. From the Home screen, press , and then tap **Settings > Accounts & sync**.
2. Tap the account that you want to remove.
3. Tap **Remove account**, and then confirm that you want to remove the account.

Social

Facebook for HTC Sense

If you signed in to your Facebook account when you turned on and set up HTC Flyer for the first time, that means your Facebook account is linked to Facebook for HTC Sense on HTC Flyer.

With Facebook for HTC Sense, you can:

- See all your Facebook contacts and their instant status updates in People.

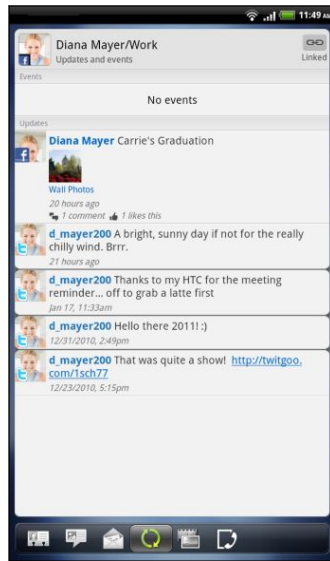

When you tap a contact on the All tab, slide to the Updates and events tab to see updates such as posted status messages, uploads, and profile changes.

When there is a notification of the contact's birthday, you can tap the notification to send a greeting.

- See Facebook photos right on the Gallery app.

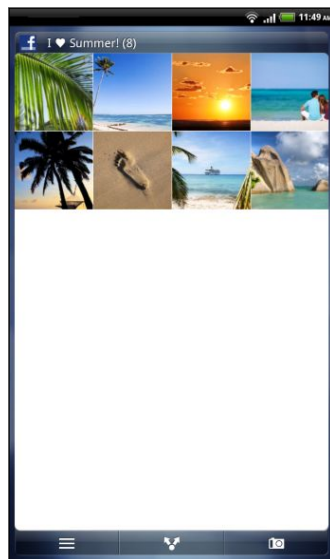

You can also upload one or more photos to Facebook, then tag and add captions that go with it.

When you're viewing the albums of a Facebook friend, you can also share a link to a particular album, or comment on the album photos.

- Check your friends' Facebook status updates in Friend Stream.
- Add your Facebook events and your friends' birthdays to the Calendar app.



Facebook app

The Facebook app lets you keep up and stay close with your friends in Facebook. It offers most of the features that you are familiar with when using Facebook on your computer.

With the Facebook app, you can:

- Share your thoughts and check other people's status updates.
- View your friends list and write on someone's wall.
- Comment on and like a friend's post.
- View someone's personal information, including photo albums.
- Check your Facebook notifications.
- Take a photo and upload it straight to your Facebook account.

Using the Facebook app

1. From the Home screen, tap  > **Facebook**.
2. If this is your first time to use Facebook, follow the onscreen instructions to sign in to your Facebook account.
3. On the News Feed screen, tap  to access the other functions.



- While on the Facebook home screen, press , and then tap **Settings** to set refresh and notification options.
- On some Facebook screens, you can press and hold an item to open an options menu.

Adding the Facebook widget

Add the Facebook widget to the Home screen so you can easily post updates and check status updates of your friends.



The widget will only link to the Facebook account that you logged into on the Facebook app.

What's the difference between Facebook app and Facebook for HTC Sense?

- Facebook for HTC Sense is not a standalone app. It is integrated in People, Friend Stream, Gallery, and Calendar to give you up-to-date information about your Facebook contacts (their status updates, shared links, and photos) in these apps.
- The Facebook app is a standalone app. Use this app to do most of the things that you would do when you're using your computer's web browser to access your Facebook account, such as adding a friend and sending Facebook messages.
- The two do not share the same login credentials. Signing in to Facebook for HTC Sense does not sign you in to the Facebook app and vice versa. If you want to use the same Facebook account for both, you'll have to sign in to both using the same login credentials.



If you have more than one Facebook account, you may sign in to the Facebook app using your second account, since the Facebook app does not share the same login credentials as Facebook for HTC Sense.

Twitter for HTC Sense

If you signed in to your Twitter account when you turned on and set up HTC Flyer for the first time, that means your Twitter account is linked to Twitter for HTC Sense on HTC Flyer. (If you did not do this, add the Twitter for HTC Sense account in **Settings > Accounts & sync.**)

With Twitter for HTC Sense, you can:

- Link your contacts in People to their Twitter profiles (if you're following them).
- Send tweets and check your friends' tweets in Friend Stream.



Twitter for HTC Sense and the Twitter for app do not share the same login credentials. Signing in to Twitter for HTC Sense does not sign you in to the Twitter app and vice versa. If you want to use the same Twitter account for both, you'll have to sign in to both using the same login credentials.

Using Friend Stream

Friend Stream connects you to your social networks. Share and get updates from friends in popular networks like Facebook and Twitter in a single feed. With Friend Stream, you can easily track your friends' status messages, photo uploads, notifications, and more — or comment and post your own.

- You must be signed in to at least one social network account to use Friend Stream.
- To use your Facebook account on Friend Stream, you need to be signed in via Facebook for HTC Sense.

From the Home screen, tap  > **Friend Stream**. Friend Stream opens on the All updates tab.

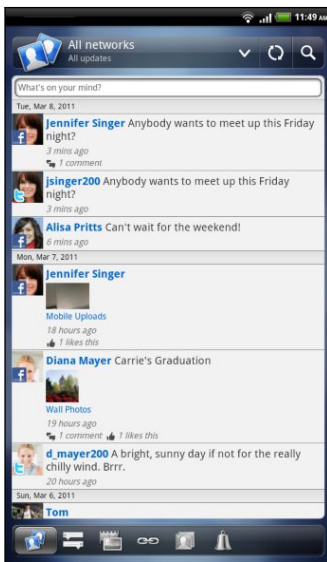

When you tap someone's status update, you can:

- View all tweets.
- Write a comment. Like or unlike someone's Facebook posts.
- Look at someone's album photos.



When you tap someone's photo or name, you can:

- Check the person's profile details.
- Look at the person's Facebook wall.
- Check the person's posted tweets.

Slide to the other tabs to view social network updates grouped as status updates only, photo uploads, links, updates from members of your Facebook list, or social network notifications.

Updating your status

You can update your status simultaneously on all the social network accounts you are signed in to.

1. From the Home screen, tap  > **Friend Stream**.
2. On the All updates tab, tap the text box that says **What's on your mind**.
3. Enter your status update.
4. If you do not want to send the status update to all your social network accounts, tap  and clear the check boxes of the social networks to exclude.

- Tap  and then choose what you want to attach to your tweet or status update.



Picture	Select From Camera to take a photo and attach it or From Gallery to attach a photo.
Location	Add your current location or a location you pick on a map.
App recommendation	Choose an app you've installed from Android Market that you want to share with others. The URL from which the app can be downloaded will be inserted to your status.

- Tap Post.

Commenting on and liking Facebook posts

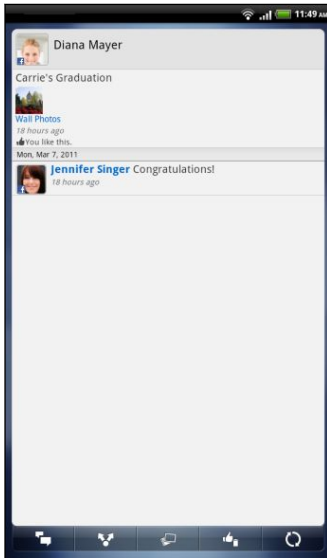
Tap someone's status update on the All updates tab, and do any of the following:



- Tap  or  to like or unlike the person's status update.
- Tap  to comment on the person's status update.

Checking notifications from your social networks

Slide to the Notifications tab to easily see a single feed of your notifications from different social networks. It can be a comment on your Facebook post, a mention or direct message in Twitter, a tagged photo of you, and more.

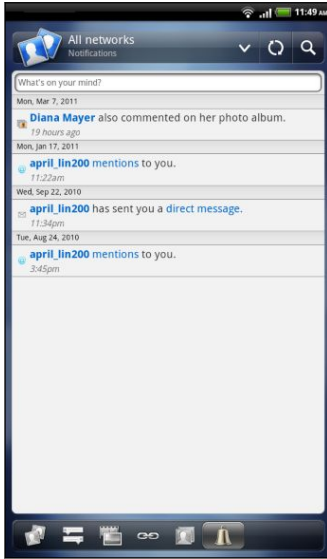





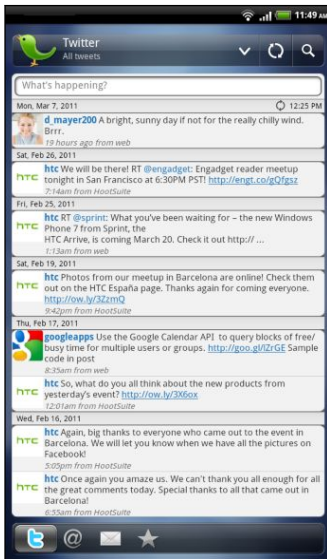

About the Friend Stream widget

Use the Friend Stream widget so you can easily update your status and view other people's status updates right on the Home screen. If you want to keep up with just one person's Facebook updates, you can add the Friend Channel widget. You can find it in the Friend Stream widget layout options.

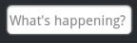

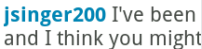
Tweeting in Friend Stream

In Friend Stream, tap the bar at the top of the screen (for example, All networks), and then tap Twitter.



	Tap to compose and send a tweet.
	Tap a person's name to check profile details and all of his or her tweets.
	If you have linked the contact in People, tap the photo or icon to open a menu where you can quickly choose how to communicate with the contact.
	Press and hold a tweet to open an options menu to reply, send a direct message, retweet, and more.
	View all the tweets from people you follow and tweets that you have posted.
	View all tweets that mention your username using the “[@your username]” convention.
	View all private/direct messages that you have received or sent.
	View tweets that you have marked as favorites.

Sending a tweet

1. On the All tweets tab, tap the text box that says **What's happening**.
2. Type your tweet.
3. Add a picture or location to your tweet.
 - Tap  to post a picture from Gallery or Camera to your default photo hosting site and add the link to the picture in your tweet.
 - Tap  to insert your location into the tweet. You can choose to add a map link, insert your location name, or insert your position coordinates.
4. Tap Post.

Searching for Twitter users to follow

1. In any of the tabs, tap .
2. Type a Twitter name in the search box, and then tap **Search online**.



If you don't see **Search online**, scroll down the screen.

3. In the list of search results, tap the Twitter user you want to follow.
4. Press , and then tap **Follow**.

Sending a direct message

You can only send a direct message to someone who is following you.



1. In any of the tabs, press , and then tap **New message**.
2. Tap the text box at the top of the screen, and then enter the name. As you enter characters, the names of the Twitter users that match the characters you enter will appear. Tap the name when you see it.
3. Enter your message, and then tap **Post**.

You can also send a direct message when you press and hold a tweet of the person you want to send the direct message to, and then tap **Send direct message** on the options menu.

Chatting in Google Talk

Google Talk is Google's instant messaging program. It lets you communicate with other people that also use Google Talk. If you signed in to your Google Account when you first set up HTC Flyer, you are already signed in to Google Talk.

Chatting with a friend

1. In Google Talk, tap a friend in the Friends list.
2. Enter your message in the text box. You can also insert a smiley by pressing , and then tapping **More > Insert smiley**.
3. Tap **Send**.
4. While chatting, press  and then tap any of these options:

Chat off record	Your Google Talk messages are stored in the Chats folder of your Gmail account. Tap this option if you don't want to store your chat messages.
Switch chats	If you have more than one chat going, tap to switch chat with another friend.
Friends list	Return to the Friends list.

Add to chat	Add another friend to your chat. The friend you invited and the friend you're currently chatting will receive an invitation to a group chat. Each one who accepts the invitation joins the group chat.
End chat	End your current chat.
More	Clear the chat history, insert a smiley or view your friend's contact details.

Accepting a chat invitation

When a friend sends you a Google Talk message, you receive a notification. Their entry in the Friends list displays the message.

Do one of the following:

- In the Friends list, tap the friend who sent you the invitation to chat.
- Open the Notifications panel, and then tap the chat notification.

Changing your online status and picture







1. In Google Talk's Friends list, tap your name to open the Set Status screen.
2. Enter your new status message. Or press  to choose a custom status from the list.
3. Tap the online status beside your picture, and then select the status you want on the menu.
4. Tap your picture, and then do one of the following:
 - Tap **Remove** to remove your photo.
 - Tap **Change** to select another picture.
5. Tap **Done**.

Your online status, message, and picture appear in your contacts' Friends list and in other apps where your Google Talk status are displayed.

Adding and managing friends

The Friends list is where you add and manage your friends in Google Talk.

In Google Talk's Friends list, you can:

Invite a friend	<ol style="list-style-type: none"> 1. Press , and then tap Add friend. 2. Enter the Google Talk instant messaging ID or Gmail address of the friend you want to add. 3. Tap Send invitation.
View all friends	Initially, only those friends that you often chat with — the most popular — are shown in the Friends list. To view all your friends, press  , and then tap All friends . To view only friends that you often chat with, press  , and then tap Most popular .
Make a friend popular	<ol style="list-style-type: none"> 1. Press , and then tap All friends. 2. Press and hold a friend's name, and then tap Always show friend.
Block a friend	<p>You can block a friend from sending you messages. When blocked, your friend is removed from the Friends list and is added to the Blocked friends list.</p> <ol style="list-style-type: none"> 1. Press , and then tap All friends. 2. Press and hold a friend's name, and then tap Block friend.
Unblock a friend	Press  , and then tap More > Blocked .
View all invited friends	Press  , and then tap More > Invites . Friends who have not yet accepted your invitation are listed on the screen.

Changing settings or signing out

In Google Talk's Friends list, press  and then tap:

- **Settings** to change the app and notification settings.
- **Sign out** to sign out.

Email

Gmail

Using Gmail

When you first set up HTC Flyer, make sure you sign into your Google Account to use Gmail. If you didn't do so, go to the **Accounts & sync** setting to sign in.

You can also set up more than one Google Account on HTC Flyer, and then switch between accounts in Gmail.

Viewing your Gmail Inbox

All your received emails are delivered to your Inbox.

From the Home screen, tap  > Gmail. Your Gmail inbox then opens.

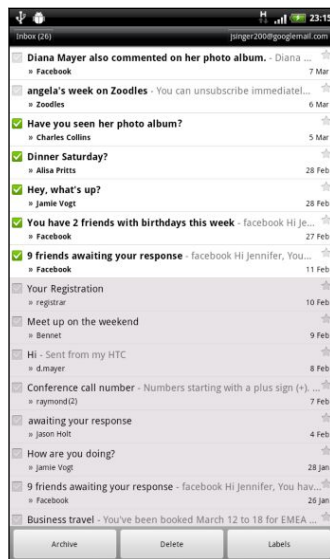

Archive or delete multiple conversations

Tap before the email or conversation. Then tap the onscreen buttons at the bottom to choose what to do with the selected messages or conversations.

Display drafts, sent messages, and other labels

Tap **Inbox** at the top left of the screen, and then tap another label (such as **Sent**, **Drafts**, or your created label) to view its messages and conversations.

Switch to your other Gmail account

Tap the current account at the top right of the screen, and then tap another account you want to switch to.

Refresh the Inbox

Press , and then tap **Refresh**.



Sending a new message

1. In the Gmail inbox, press  and then tap **Compose**.
2. If you've set up multiple Google Accounts on HTC Flyer, choose which Gmail address you want to use for sending your email. Tap the box that shows your current Gmail address, and then tap another address that you want to use for sending.



3. Enter the message recipient's email address in the **To** field. If you are sending the email to several recipients, separate the email addresses with a comma.





If you want to send a carbon copy (Cc) or a blind carbon copy (Bcc) of the email to other recipients, press  and then tap **Add Cc/Bcc**.

4. Enter the email subject, and then compose your email.
5. If you want to attach a picture, press  and then tap **Attach**.
6. Locate and then tap the picture you want to attach.
7. After composing your message, tap .



While composing the message, tap  to save it as a draft. Or press  to discard the message.

Replying to or forwarding an email message

1. In the Gmail inbox, tap the email message or conversation.
2. To reply to the sender, tap . Or, tap  and choose whether to **Reply all** or **Forward**.
3. Do one of the following:
 - If you selected **Reply** or **Reply all**, enter your reply message.
 - If you selected **Forward**, specify the message recipients.



Tap **Respond inline** if you want to interleave your new message with the received email. But this removes any attachments or formatting in the original email.

4. Tap .

Getting help

To find out more about using Gmail, press , and then tap **More > Help**. The web browser will take you to the Google Mobile Help site.

Mail



About the Mail app

Use the Mail app to add your webmail and other POP3 or IMAP email accounts. You can also set up and use your Exchange ActiveSync email on HTC Flyer.



You can add the Mail widget to view your POP3/IMAP or Exchange ActiveSync emails on the Home screen.

Adding a POP3/IMAP email account



1. From the Home screen, tap  > Mail.
2. Do one of the following:
 - If this is your first time to add an email account in Mail, tap **Other (POP3/IMAP)** on the Choose a mail provider screen.
 - If you've already added an email account in Mail, press , and then tap **More > New account**. If the Choose a mail provider screen is displayed, tap **Other (POP3/IMAP)**.
3. Enter the email address and password for your email account and then tap **Next**.
4. If the account type you want to set up is not in the internal database, you'll be asked to enter more details.
5. Enter the account name and your name and then tap **Finish setup**.

Adding a Microsoft Exchange ActiveSync account

You can add one or more Microsoft Exchange ActiveSync accounts on HTC Flyer. You can sync with Microsoft Exchange Server 2003 Service Pack (SP2) or later.



You can add up to 15 Exchange ActiveSync accounts on HTC Flyer.

1. From the Home screen, tap  > Mail.
2. Do one of the following:
 - If this is your first time to add an email account in Mail, tap **Microsoft Exchange ActiveSync** on the Choose a mail provider screen.
 - If you've already added an email account in Mail, press , and then tap **More > New account**. If the Choose a mail provider screen is displayed, tap **Microsoft Exchange ActiveSync**.
3. Enter the Exchange ActiveSync account details, and then tap **Next**. If your corporate Exchange Server does not support auto-detect, you'll need to enter your Exchange Server settings after you tap **Next**. Ask your Exchange Server administrator for details.
4. Choose the types of information you want to sync. Also choose how often you want to update and sync email to HTC Flyer, then tap **Next**.
5. Enter the account name, then tap **Finish setup**.

Checking your Mail inbox

When you open the Mail app, it displays the inbox of one of your email accounts that you've set up on HTC Flyer.

To switch between email accounts, tap the bar that shows the current email account, and then tap another account.

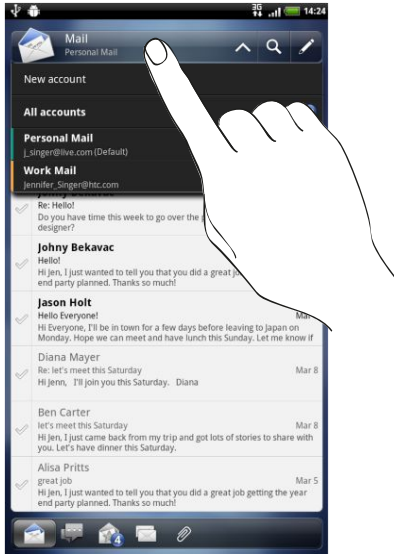

Viewing the unified inbox of all your email accounts

You can view email messages from all your accounts just in one place without having to switch to different accounts.

Just tap the bar that shows the current email account, and then tap **All accounts**. Email messages are color coded so you can easily distinguish which email accounts they belong to.



Up to 15 email accounts can be shown in the unified inbox.

Switching between different views of your inbox

If you have lots of email messages, it may take you some time to browse through the long list and find a single email or related email messages. Use the tabs of the Mail app to sort your emails into different categories.

To skim through your email messages easier, tap one of the following tabs to change the view of your inbox:









Inbox

Displays email messages as individual items.



Conversations

Displays email messages as conversations, grouped according to the subject line. Tap a subject in the list to show the email conversation.

	Group Displays all email messages from a contact group. To choose which contact group to display, press  , tap View , and then select a group.
	Unread Displays unread messages.
	Marked (Exchange ActiveSync only) Displays all flagged messages.
	Invites (Exchange ActiveSync only) Displays meeting invitations which you have not yet accepted or declined.
	Attachments Displays all messages that have attachments.

Previewing email messages

You can preview email messages while you're browsing through the messages in your inbox or any mail folder.

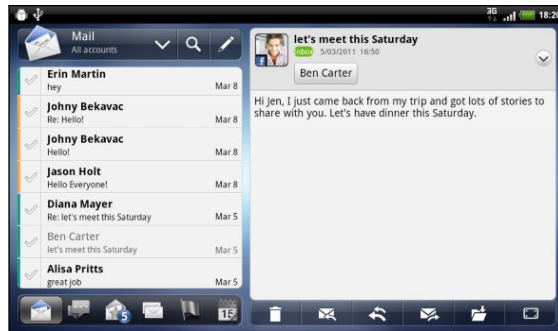

- Turn HTC Flyer to the left and hold it in landscape orientation to see a split-window preview, with the email list on the left and the preview of the selected message on the right.



- While in landscape orientation, tap  to view the email message in full screen. To change back to the split-window preview, tap .

Refreshing an email account

Whatever your automatic synchronization settings are, you can also synchronize your sent and received emails manually at any time.

- While in the account you want to synchronize, press , and then tap **Refresh**.
- If you have several email accounts, you can refresh them all at the same time. Go to the unified inbox first. Then press  and tap **Refresh**.

Sorting email messages

You can sort email messages by date received, priority, subject, sender, or size.

On the inbox, press , tap **Sort**, and select from the sorting options.

Quickly browsing your inbox

If you have a long list of email messages in your inbox, it may not be easy to browse the list and find an email that you want. You can quickly browse through your inbox by using finger gestures.

1. Choose a sorting order for displaying your email messages.
2. Press and hold two fingers on any email message, and then drag upward or downward without lifting your fingers. Your screen then jumps to the set of email messages based on your chosen sorting order.

Managing email messages

Deleting an email message

1. On the inbox, press and hold the message you want to delete.
2. On the options menu, tap **Delete**.

Selecting several email messages

1. Tap the check boxes of email messages to select them.
2. Choose what you want to do with the selected messages: **Mark read** (or mark **Mark unread**), **Delete**, or **Move to** another folder.



You cannot move email messages when you're in the unified (All accounts) inbox.

Moving several email messages to another folder

1. Switch to the email account you want to use.
2. Tap the check boxes of email messages you want to move.
3. Tap **Move to**, and then tap the folder where to move the email messages.

Moving an email message after reading

1. In the open message, tap .
2. Tap the folder where you want to move the email message.



Deleting all messages

1. First tap the check box of any email message.
2. Press , and then tap **Select all**.
3. Tap **Delete**.

Switching to other mail folders

1. Press , and then tap **Folders**.
2. Tap the mail folder whose messages you want to view.

Sending an email message

1. From the Home screen, tap  > **Mail**.
2. Switch to the email account that you want to use for sending email.
3. On the email account inbox, tap .
4. Fill in one or more recipients. You can:
 - Enter email addresses directly in the **To** field, separating them with a comma. As you enter email addresses, any matching addresses from your contacts list are displayed. Tap a match to enter that address directly.
 - Tap the  icon, and then choose the contacts to whom you want to send the message. You can also select contact groups as recipients, or search and add contacts.

If the contact name you entered is not found and you have an Exchange ActiveSync account in the Mail app, you can search for the contact in your company directory.



If you want to send a carbon copy (Cc) or a blind carbon copy (Bcc) of the email to other recipients, press , and then tap **Show Cc/Bcc**.

5. Enter the subject, and then compose your message.
6. To add an attachment, press , tap **Attach**, and choose from the following options:

Picture	Take a photo and attach it, or attach an existing photo.
Video	Record a video and attach it, or attach an existing video.
Audio	Attach an audio file.
App recommendation	Choose an app you've installed from Android Market that you want to tell other people about. The URL from which the app can be downloaded will be inserted in your email.
Location	You can attach location information. Send your current location (requires GPS to be turned on) or a location you pick on a map.
Document	Attach a PDF file or an Office document such as a text file or a spreadsheet.
Contact (vCard)	Attach someone's contact information.

Appointment (vCalendar)	Attach a calendar event.
File	Attach any other file.

7. Tap **Send** to send the message immediately, or tap **Save as draft** to send it later.



If there's no Wi-Fi or data connection available or Airplane mode is on when you send your email, the email will be saved to the Outbox folder. Once there's Wi-Fi or data connection available, the saved email will be sent automatically next time HTC Flyer syncs.

Resuming a draft email message

1. In the email account inbox, press , and then tap **Folders > Drafts**.
2. Tap the message.
3. When you finish editing the message, tap **Send**.

Reading and replying to an email message

1. From the Home screen, tap  > **Mail**.
2. Switch to the email account you want to use.
3. On the email account inbox, tap the email you want to read.
4. Do any of the following:

Reply to the message	Tap  or  .
Forward the message	Tap  .
Delete the message	Tap  .
Mark the message as unread	Press  , and then tap Mark unread .

Setting the priority for an email message

You can set the priority for an email message that you send.



1. While composing the message, press .
2. Tap **Set priority**.
3. Select the priority for the message.

If you selected **High** or **Low** priority, the priority appears below the subject line of the message.

Working with Exchange ActiveSync email

You can read, reply, send, and manage your work email in the same easy way as with a POP3/IMAP account. In addition, you can also use some powerful Exchange features.

Flagging an email

- While viewing the inbox, tap the white flag icon  that appears on the right of an email message. The icon turns red  after you flagged the email.
- While reading an email, you can also tap the flag icon in the email.

Setting your Out of the office status

1. Switch to your Exchange ActiveSync account.
2. Press  and then tap **More > Out of the office**.
3. Tap the box, and then select **Out of the office**.
4. Set the dates and times for the period when you will be out of the office.
5. Enter the auto-reply message.
6. Tap **Save**.

Sending a meeting request

1. Switch to your Exchange ActiveSync account.
2. Go to the Invites tab, and then tap .
3. Enter the meeting details.
4. Tap **Send**.

Changing email account settings

1. Switch to the email account whose settings you want to change.
2. Press , and then tap **More > Settings**.
3. Select from the following:

Account settings	Change the email account settings such as the name, email address, password, and description.
General settings	Set the font size when reading emails, enable, disable or set the signature, set the account as the default email account, and set where to save email attachments.
Send & Receive	Set the sync settings for incoming and outgoing emails such as maximum size limit, update schedule, and more.

Notification settings	Set email notification settings.
Delete account	Tap to delete the email account.

4. Press  to save your changes.

Deleting an email account

1. Switch to the email account you want to delete.
2. Press , and then tap **More > Settings > Delete account**.

Calendar

About Calendar

Never miss an important date again. Use the Calendar app to schedule your events, meetings, and appointments.



You can set up HTC Flyer to stay in sync with the following types of calendars:

- On HTC Flyer, sign in to your Google Account so you'll be able to sync the Calendar app with your Google Calendar online. You can add multiple Google Accounts.
- If you're using Microsoft Outlook® on your computer, you can set up HTC Sync on your computer to sync Outlook Calendar with the Calendar app.
- If you have a Microsoft Exchange ActiveSync account and you've added it on HTC Flyer, you can sync the Calendar app with your Exchange ActiveSync calendar events.

If you've signed in to your social network accounts such as Facebook, birthdays and events of friends will appear in Calendar.

Creating an event

You can create events that sync with your Google Calendar, your computer's Outlook Calendar, or Exchange ActiveSync calendar, as well as events that appear on HTC Flyer only.

1. From the Home screen, tap  > **Calendar**.
2. On any Calendar view, tap .
3. If you have more than one calendar, select a calendar in which to add the event:
 - Select your Google Account to create a Google Calendar event. If you have several Google calendars on the Web, select one in which to add your event.
 - Select **PC Sync** to create calendar events on HTC Flyer. You can sync them with your computer's Outlook Calendar using HTC Sync.
 - Select your Exchange ActiveSync account to create an Exchange ActiveSync calendar event.
4. Enter a name for the event.

5. To specify the date and time of the event, do one of the following:
 - If there is a time frame for the event, tap the **From** and **To** date and time to set them.
 - If it is a whole-day event, such as a birthday, set the **From** and **To** date, then select the **All day** check box.
6. Enter the event location and description.
7. Set the reminder time.



You can add another reminder time in a Google Calendar event. Press  and then tap **Add reminder**.

8. If the event occurs on a regular basis, tap the **Repetition** box and then choose how often the event occurs.
9. Tap **Save**.

Inviting guests to your event (Google Calendar only)



After you invite guests to your event, an invitation email will be sent using your Google Account.

If you want to invite guests to your event, you need to create and add the event in your Google Calendar.

1. Open Calendar and create a new event. Tap the **Calendar** field and then select your Google Account (or one of your other Google Calendars).
2. Add details about the event, such as date and time, location, and more.
3. In the Guests field, enter the email addresses of everyone you want to invite to the event. Separate multiple addresses with commas (.). If the people to whom you send invitations use Google Calendar, they'll receive an invitation in Calendar and by email.
4. Tap **Save** to add the event to your Google Calendar.

Sending a meeting request using Calendar (Exchange ActiveSync only)

If you have an Exchange ActiveSync account set up on HTC Flyer, you can use Calendar to create a meeting appointment and send a meeting request email to the people you want to invite to your meeting.

1. Open Calendar and create a new event. Tap the **Calendar** field and then select your Exchange ActiveSync account.
2. Add details about the meeting, such as date and time, location, and more.
3. Press  and then tap **Meeting invitation**.
4. Tap  and choose attendees from your contacts or the company directory.
5. Enter your message and then tap **Send**.

Changing Calendar views

When you open Calendar, it displays the month view by default.

To change to another view, simply tap **Day**, **Week**, or **Agenda**.

Using month view

In month view, you will see markers on days that have events.

Do any of the following in month view:

- Tap a day to view the events for that day.
- Press and hold a day to open an options menu from which you can also choose to create an event or switch to either day or agenda view.
- Slide your finger up or down the screen to view earlier or later months.

Using day and agenda views

Day view displays a list of the events of one day and also shows weather information at the bottom of the screen when you're viewing events of the current day.



In day view, the weather information appears only if the event is within the five-day forecast of the Weather app.

Agenda view shows a list of all your events in chronological order.

- The colored bars on the left side of the events indicate the type of calendar the event is part of. To find out what each color represents, tap .
- When in day view, slide left or right across the screen to view earlier or later days.

Using week view

Week view displays a chart of the events of one week.



When in week view, you can:

- Press and hold on a time slot to create a new event at that time.
- Tap an event (shown as colored blocks) to view its details.
- Slide left or right across the screen to view earlier or later weeks.

Managing Calendar events

Viewing an event

You can view your own events as well as events that other people have shared with you.

1. In day view or agenda view, tap an event. The Event details screen then opens and shows the summary of the event.
2. Depending on the event information, do any of the following:
 - Find the event's location in Maps.
 - Check the participants of the event.
 - If the event was sent as a meeting invitation, respond to the invitation.
 - If it's an Exchange ActiveSync calendar event, reply by email to the organizer or to all the guests. Press , and then either tap **Reply** or **Reply all**.
 - Select any text and look it up on the Web.
 - Tap the reminder time to change it. Press  to save changes.



Need to jot down discussion points? While viewing a calendar event, tap **Create note**. Or maybe you'd like to link an existing note to your event. Press , and then tap **More > Associate note**. The Notes app will open.

Editing an event

You can edit events that you have created.

1. While viewing an event, press , and then tap **Edit event**.
2. Make your changes to the event.
3. When you're done editing, tap **Save**.

Deleting an event

Do any of the following:

- While viewing the summary of an event on the Event details screen, press  and then tap **Delete event**.
- In day, agenda or week view, press and hold an event and then tap **Delete event**.
- When editing an event, tap **Delete**.

If the event repeats, you'll be asked whether you want to delete just that occurrence, this and all future occurrences, or all past and future occurrences in your Calendar.

Sharing an event (vCalendar)

You can share a calendar event as a vCalendar using Bluetooth or by sending it as a file attachment with your email or message.

1. While viewing an event, press , and then tap **Share vCalendar**.
2. Do one of the following:
 - Tap **Bluetooth**. You'll be asked to turn on Bluetooth on HTC Flyer and connect to the receiving Bluetooth device.
 - Tap **Mail**. A new message window opens and automatically includes the vCalendar as an attachment. Your default email account will be used to send the message.
 - Tap **Message**. A new message window opens and automatically includes the vCalendar as a multimedia attachment.

Dismissing or snoozing event reminders

If you have set at least one reminder for an event, the upcoming event icon  will appear in the notifications area of the status bar to remind you of the upcoming event.

1. Tap the status bar, then slide your finger down the screen to open the Notifications panel.
2. Do one of the following:
 - Tap **Clear** to dismiss event reminders and all other notifications. Other types of notifications such as new messages and missed calls will also be deleted.
 - After sliding open the Notifications panel, tap the calendar event reminder. You'll then see a list of all pending event reminders. Tap **Snooze all** to snooze all event reminders for five minutes, or tap **Dismiss all** to dismiss all event reminders.
 - Press  to keep the reminders pending in the notifications area of the status bar.

Showing or hiding calendars

In any Calendar view, tap , and then select or clear a calendar to show or hide it.



Calendars are kept synchronized on HTC Flyer, whether or not you hide them.

Changing Calendar settings

You can change Calendar settings to specify how it displays events and how it notifies you of upcoming events.

In any Calendar view, press  and then tap **Settings** (or **More > Settings**).

Reminder settings

All calendars	Select this check box to use the same event reminder settings for all types of calendars. If you clear this check box, you can set different reminder settings for each calendar.
Set alerts & notifications	Configure event reminders to open an alert, send you a notification, or turn off event notifications on HTC Flyer.
Default reminder time	Choose how soon before an event you want to be notified.
Select ringtone	Choose a ringtone to sound when you receive an event reminder.
Hide declined events	Choose whether to show or hide events for which you've declined invitations.

Calendar view settings

Start in	Choose the default view to display when you open Calendar.
First day of week	Set the month and week views to start on a Sunday or Monday.
Include weather	Select this check box to show weather information in the day view events list.
City	If weather is included, by default, day view displays your current location's weather. You can change it to display the weather of another city.

About the Calendar widget

You can add a Calendar widget to your Home screen. The widgets offer different calendar views.

Tapping a day or event on the widget brings you to the Calendar app.

Maps and location

Turning on location services

In order to find your location on HTC Flyer, you need to enable location sources.

1. From the Home screen, press  and then tap **Settings > Location**.
2. Select one or both of the following:

Use wireless networks	Uses Wi-Fi or your mobile data connection to find your approximate location.
Use GPS satellites	Finds your exact GPS location. This requires a clear view of the sky and more battery power.

About Locations



Search for places of interest, get directions to places you want to go to, and drive using turn-by-turn GPS navigation with Locations. Locations is also your perfect travel companion, whether you're at home or when you're in a different country. With Locations, you can download maps beforehand so you don't have to worry about having an Internet connection while on the road or costly data roaming charges when abroad. Have your map ready before you start your journey.



If you are in an area where there are a lot of surrounding buildings, Locations may have a hard time pinpointing your location.

HTC Flyer comes with an installed map, which depends on the country where you bought it. Don't worry, you can download other maps when you need them.

Finding your location and what's around you

1. From the Home screen, tap  > **Locations**.
2. Tap  to update your current location or tap  to show your current location on the map.
3. Select a category that you're interested in to see the places that are close by. The places are listed according to the distance from your current location.

Searching for a place of interest

You can search using a name of an establishment, street, or city. As you enter the place to look for, suggested matches from the database, footprints, and previously searched items are displayed.

1. In Locations, tap .
2. Enter the place you want to search in the search box. Matching establishments are shown sorted by the distance from your current location.
3. If you don't see what you are looking for, keep entering characters to narrow down the search.



Search is done in your current country. If you want to do a search on a different country, tap **Current search region**.

4. Tap an establishment to get directions, show on map, and more.

Searching for an address

1. In Locations, tap .
2. Enter the street or city name you want to find (you don't need to enter the complete address) in the search box. A list of suggestions will appear to guide you to what you're looking for.

For example, to find “321, Church Street, London, UK”, just enter “Church” or “London” to start your search.





You can also search by entering a zip code. Just enter the zip code in the search box, and then tap .

Viewing maps

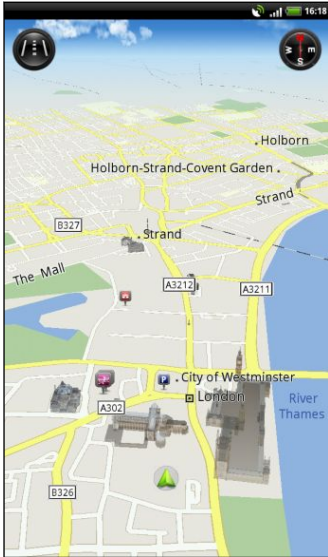
In Locations, tap .



 Tap to switch between 2D and 3D views.

 Point of interest. Tap to see details, call, get directions, or share.

 Your current location.

 Tap to use or not use the compass.

Tap the screen to show the zoom buttons and My location  button.

Using the compass

Should I turn left or right? By using the compass, the map adjusts depending on where you're facing so you know where to go.

Moving around the map

Swipe your finger on the screen to view other areas of the map.

Zooming in or out of a map

Do one of the following:

- Spread your thumb and index finger across the map to zoom in.
- Pinch your thumb and index finger on the map to zoom out.
- Double-tap a location on the map to zoom in to that location.

Choosing which places of interest to show on the map

1. While viewing a map, press  and then tap **View** (or **More > View**).
2. Choose the points of interest you want or don't want to see when you're viewing a map.



You can also choose to show or not show footprints and 3D buildings on the map.

3. Tap Done.

Pinning a location on the map



Pin a favorite location on the map and add it as a footprint, get directions to it, or share it with friends. Sharing is a great way to let your friends know about that little place you found that has the best sandwiches in town.

1. While viewing a map, press and hold an area on the map that you want to pin.
2. Tap  and then choose if you want to add the location as a footprint, get directions to it, or share it.



To remove all the pins on the map, while viewing a map, press , and then tap **More > Clear pin**.

Changing the language of street names and places of interest

1. From the Home screen, tap  > **Locations**.
2. On the Nearby tab, press , and then tap **Settings > Map > Map language**.
3. Choose one of the following.

Use native map language	Use this if you want to use the local language of the map. For example, if you are looking at a map of Japan, it will use Japanese characters.
Use language that fits best	Use this if you want to use your current language settings. This may not be available for all maps.





Recording favorite places as footprints

A footprint consists of a photo of a location such as a restaurant, a sightseeing destination, etc., stored together with a precise GPS position and other information about that location such as the street address and phone number.

The next time you want to visit the same place, just open the footprint. You can then view the location on the map, search for it on the Web, and more.

Adding a location as a footprint

1. Search for the destination you want to go to.
2. Tap **Save to Footprints**.

3. You can:
 - Tap  to take a picture and add it as a photo for the footprint.
 - Tap  to fine tune the position of the footprint on the map.
 - Tap  to add a note for the footprint.
 - Tap **Select categories**, and then choose the appropriate labels for the location.
 - Press , and then tap **Record voice** to add a voice memo to the footprint.
4. Tap **Done**.

Setting a footprint as your home location

Save your home address as a footprint to make it easier to set it as your destination.

1. While at your home location, open Locations, and then go to the Footprints tab.
2. Under Current Location, tap .
3. Tap **Done**.
4. Tap **Set my home**, select your home address from the list, and then tap **Done**.



To change your home address at any time, tap .

Revisiting a footprint

1. On the Footprints tab, tap a category.
2. Tap the footprint you want to revisit.
3. Tap the information fields to get directions, share the footprint, search the Web, and more.

Editing or deleting a footprint

1. On the Footprints tab, tap a category.
2. Press and hold the footprint you want to edit or delete.
3. Tap **Edit** or **Delete** on the options menu.

Sharing your footprints

1. Create a footprint.
2. On the Footprints tab, tap the footprint that you have just created.
3. Tap **Share**, and then choose how you want to share the footprint.

Deleting multiple footprints

1. On the Footprints tab, tap a category.
2. Press , and then tap **Delete**.
3. Select the footprints you want to delete, and then tap **Delete**.

Exporting your footprints

Back up footprints by exporting and saving them as .kmz files on the internal storage. You can also open exported footprints files in other applications such as Google Earth™ on your PC.

1. On the Footprints tab, tap a category.
2. Press , and then tap **Export**.



Press  and then tap **Deselect all** to deselect all the footprints.

Exported footprints are saved as .kmz files in the Footprints folder on the internal storage. If you exported multiple footprints at one time, they are saved together in one .kmz file.

Importing footprints

Bring back footprints you previously backed up on the internal storage. You can also import .kmz files that you saved in other applications, or use a photo as a footprint.

1. On the Footprints tab, press , and then tap **Import**.
2. Do one of the following:
 - To import a photo, tap **Photos**, navigate to the photo you want to import, and then tap the photo. You can then add Footprints information such as location and category.
 - To import a saved footprint or another .kmz file, tap **Footprints data**, and then tap the file you want to import.

Getting directions

Get detailed driving or walking text instructions on how to get to your destination.



Getting directions from your current location

1. In Locations, search for the destination you want to go to.



You have footprints saved? You can also set a footprint as your destination. Just go to the Footprints tab, and then choose a footprint.

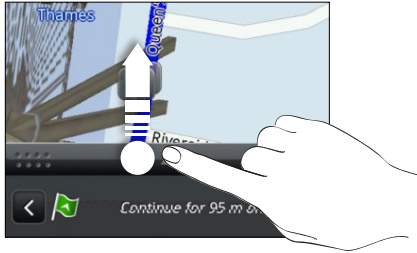

2. Tap **Directions**.

3. Choose how you want to get to your destination. The map opens showing the route to your destination.
4. Do one of the following:
 - At the bottom of the screen, tap  or  to follow the route to your destination.
 - Slide up the directions bar, and then tap the instructions to follow the route to your destination.



If you have turn-by-turn navigation for that country, press , and then tap **Premium Navi** to start turn-by-turn navigation.

Getting directions by setting a start and end location

1. While viewing the map, press , and then tap **Directions**.
2. Tap the **My location** text box, and then search for the starting location you want.
3. Tap the **End point** text box, and then search for the destination you want.
4. Tap **Driving** or **Walking** depending on how you want to get to your destination.
5. Do one of the following:
 - At the bottom of the screen, tap  or  to follow the route to your destination.
 - Slide up the directions bar, and then tap the instructions to follow the route to your destination.



If you have turn-by-turn navigation for that country, press , and then tap **Premium Navi** to start turn-by-turn navigation.

Using turn-by-turn navigation (Premium navigation)

- To use turn-by-turn navigation, the **Use GPS Satellites** option in Location sources needs to be selected.
- Check if you have the turn-by-turn navigation for the country or region you're using.

Using Locations to navigate to a destination

1. In Locations, search for the destination you want to go to.



You have footprints stored? You can also set a footprint as your destination. Just go to the Footprints tab, and then choose a footprint.

2. Tap **Premium navigation**.

While navigating, you can tap the screen to see what other options are available.

Setting navigation preferences

Choose how you want Locations to map your route. You can tell Locations to avoid highways or toll roads, show lane information, choose your route preference, and more.

1. While using turn-by-turn navigation, tap the screen.
2. Tap **Car Panel > Settings > Navigator**.
3. Set your preferences by selecting or tapping an item.

Turning off speed and safety camera alerts







If you have the safety camera service, you can choose to turn this service off temporarily.

1. While using turn-by-turn navigation, tap the screen.
2. Tap **Car Panel > Settings > Warnings**
3. Clear the **Speed warning** and **Safety camera warning** check boxes.

Using Car Panel

Easily access footprints, points of interest, and places nearby with Car Panel, and then start navigation to show you how to get there.

From the Home screen, tap  > **Car Panel**.

	Search for a destination to go to.
	Check points of interest near your current location, such as shops or banks.
	Download or purchase additional services such as navigation, safety camera, and turn-by-turn voice instructions.
	Select a footprint to set as a destination.
	Check the places you've search before, and then choose one to set as your destination.
	Set Car Panel options.

Car Panel keeps opening by itself when you're using a mini-to-micro USB converter?

If you connect a mini-USB power adapter or car charger to HTC Flyer through a mini-to-micro USB converter, HTC Flyer may misinterpret this to be a car kit connection (due to the different connector PIN assignment on the mini-USB power adapter or car charger) and automatically display the Car Panel.

You can prevent Car Panel from automatically opening by:

1. From the Home screen, press , and then tap **Settings**.
2. Tap **Dock**, and then clear the **Auto-launch** check box.

Using HTC Flyer with the car kit

If you purchased the dedicated car kit for HTC Flyer, you can use the included in-car holder to mount HTC Flyer securely inside your car and use HTC Flyer on the road. Refer to the car kit guide for instructions on how to install the in-car holder and properly mount HTC Flyer to the holder.

When you mount HTC Flyer on the car kit, the Car Panel automatically opens.

Automatically connecting to a Bluetooth car kit or headset



You can set HTC Flyer to automatically connect to a Bluetooth car kit or Bluetooth headset you've paired with, whenever you mount HTC Flyer on the in-car holder.

1. In Car Panel, tap **Settings > Car kit**.
2. Select the **Auto-connect** check box.
3. If you have more than one Bluetooth car kit or headset paired with HTC Flyer, tap **Default device** to choose the Bluetooth car kit or headset to use.

Before mounting HTC Flyer on the in-car holder, make sure that its Bluetooth and the paired Bluetooth car kit or headset is turned on.

Managing Locations services

Check maps, navigation, safety camera information, and voices for turn-by-turn voice instructions that are already on HTC Flyer.



1. From the Home screen, tap  > **Locations**.
2. Press , and then tap **Get more**. In the My licenses & content tab, you'll see a list of services that are already on HTC Flyer.

Downloading maps or purchasing services

Going to a different country for vacation? You can download the map of the country you're going to for free. You can also download or purchase additional services such as navigation, safety camera, and turn-by-turn voice instructions.



You need a data or Wi-Fi connection to download or purchase maps and services.

1. From the Home screen, tap  > **Locations**.
2. Press , and then tap **Get more**.
3. Slide to the tab of the item or service that you want to download.
4. Depending on what you selected, tap **Download** or **Purchase**.

Depending on the country where you bought HTC Flyer, you may only need to enter a voucher code to activate turn-by-turn navigation. If you have a voucher code, enter it by tapping **Voucher code** at the top of the Purchase navigation tab.

Adding navigation widgets

Add a favorite destination and places of interest that are nearby and your footprints as widgets on your Home screen. Add the Navigate widget to start turn-by-turn navigation to your favorite destination. Add the Locations widget to let you browse places of interest and your footprints right on the Home screen.

About Google Maps

Google Maps lets you track your current location, view real-time traffic situations, and receive detailed directions to your destination. It also provides a search tool where you can locate places of interest or an address on a map, or view locations at street level.





- You need an active mobile data or Wi-Fi connection to use Google Maps.
- To find your location with Google Maps, you need to enable location sources.
- The Google Maps app does not cover every country or city.

Getting around maps

When you open Google Maps, you can easily find your location on the map or check out nearby places by panning and zooming in and out on the map.



To find your location with Google Maps, you need to enable location sources.

1. From the Home screen, tap  > **Maps**.
2. Tap  to show your current location. The blue marker  shows your location on the map.
3. Do any of the following:

Move around

Swipe your finger to any direction on the screen to view nearby places on the map.



Zoom in

- Place your thumb and index fingers on top of the area that you want to zoom in, and then spread your fingers across the map.
- Tap .
- Double-tap the area on the map that you want to zoom in.

Zoom out	<ul style="list-style-type: none"> ▪ Pinch your thumb and index finger on the map to zoom out. ▪ Tap .
View information for a random location	<ol style="list-style-type: none"> 1. Press and hold a location on the map. A balloon opens over the location, with the address and a thumbnail from street view (if available). 2. Tap the balloon to see more information. <p>You can get directions to the location, check for nearby places of interest, and more.</p>

Searching for a location

In Google Maps, you can search for a location, such as an address or a type of business or establishment (for example, museums).

1. In Maps, enter the place you want to search for in the search box.
2. Tap  to search for the location you entered or tap a suggested search item. The search results are displayed as markers on the map.
3. Do any of the following:
 - Tap a marker  to see if that is what you're looking for, tap the balloon if it is.
 - Tap  to show the search results as a list, and then tap the location.

Details about the selected location displays on the screen.

4. Do any of the following:
 - Tap the onscreen buttons to view the location on a map, get directions, view the location in Street View, if available, and more. Scroll down the screen to view more options.
 - Swipe left or right across the screen to view the information for the next or previous search result.

Clearing the map

After searching on a map, you can clear away the various markers drawn on it.

Press , and then tap **Clear Map**.

Searching for a place of interest near you

Use Places to find places of interest near your current location. Places uses Google Maps to search common places that you would want to find, such as the nearest gas station or ATM kiosk.





Before using Places, you need to enable location sources.

1. From the Home screen, tap  > **Places**.
2. Tap the place you want to search.
3. Do any of the following:
 - When one or two places of interest are found, the search results are displayed as markers on the map. You can tap the marker, and then tap the balloon to view more information about the place.
 - When several places are found, the search results display in a list. Tap a place to show its location on a map, and then tap its balloon to view more information about the place.

Getting directions

Get detailed directions to your destination. Google Maps can provide directions for travel by foot, public transportation, or car.

1. While viewing a map, press , and then tap **Directions**.
2. Do any of the following:
 - Use your current location as the starting point, or enter a location from where to start in the first text box. Then enter your destination in the second text box.
 - Tap  to select an address from your contacts or a point that you tap on a map.

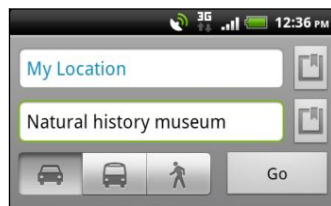

3. Choose how you want to get to your destination by tapping the car, public transit, or walk button.

4. Tap **Go**. The next screen displays the directions to your destination in a list.



If the place you've set as your destination has several locations available, choose which one to go to.

5. Tap an item to view the directions on the map.
6. Tap the arrow buttons on the map to follow the directions.

When you're finished viewing or following the directions, press  and then tap **Clear Map** to reset the map. Your destination is automatically saved in the Google Maps history.

Getting help

Get help and more information about Maps.





To open the help, press , and then tap **More > Help**. The web browser opens and takes you to the Google Maps Help site.

Finding your friends with Google Latitude (available by country)

Google Latitude user location service lets you and your friends share locations and status messages with each other. It also lets you send text and email messages, make phone calls, and get directions to your friends' locations.

Your location is not shared automatically. You must join Latitude, and then invite your friends to view your location or accept their invitations. Only friends that you have explicitly invited or accepted can see your location.

Opening and joining Latitude

1. From the Home screen, tap  > **Maps**.
2. While viewing a map, press  and then tap **Join Latitude**.
3. After you've joined Latitude and closed the application, you can do any of the following to open it from the Home screen:
 - Tap  > **Latitude**.
 - Open Maps, press , and then tap **Latitude**.

People

Transferring contacts from your old phone

Easily transfer contacts from your old phone to your new HTC phone through Bluetooth. Depending on your old phone's model, you may also transfer other types of data such as calendar events and text messages to your new phone.

1. From the Home screen, tap  > **Transfer**.
2. Tap **Next** to begin.
3. Choose your old phone's name and model.
4. On your old phone, turn Bluetooth on and set it to discoverable mode.
5. On your new HTC phone, tap **Next** to continue. Your new phone automatically turns Bluetooth on and searches for Bluetooth devices.
6. From the device list, choose your old phone and then tap **Next**. Your new HTC phone then tries to pair with your old phone. You'll see a security passkey on the screen.
7. On your old phone, enter this passkey or simply confirm it.
8. Select the **Contacts** check box (and other supported types of data you want to import), and then tap **Next**.
9. When your new HTC phone finishes importing data, tap **Done**.

About the People app

With the People app, easily manage your communications with your contacts via phone, messaging, and email. You can also link your contacts to their social network accounts like Facebook and Twitter to see their updates and events from these accounts all in one place.

And that's not all. If you have the same contacts from different sources, People lets you merge their contact information so you won't have duplicated entries in your contacts list.

1. From the Home screen, tap  > **People**.
2. Tap one of the following tabs:



All

Gives you access to all contacts on your phone, online accounts, and more.



Groups

Lets you assign contacts to groups so you can easily send an SMS, MMS, or email message to a whole group.



Call History

Lists all your dialed numbers and received and missed calls.



Your contacts list

The People app's All tab  shows all contacts on your phone and from the online accounts you're logged in to.

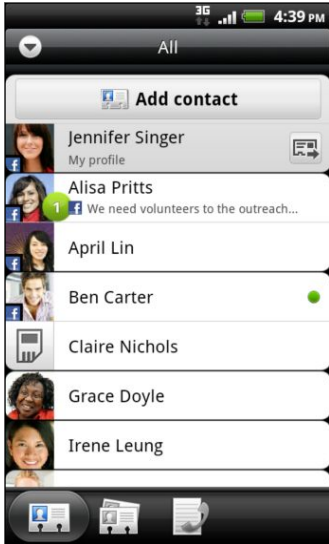
Your contacts list also displays the contacts stored on your SIM card (usually marked with the SIM card icon ).



From the All tab, you can:

- Open or update your contact information.
- Create, edit, or find contacts.
- View instant status updates when you've linked the contact to his or her social network account.
- Tap the contact's name to open the contact details screen for that contact.
- See a notification icon  when the contact has sent you a new message, tried to call you, updated his or her social network accounts, or when it's the contact's birthday.
- Check out who's online in Google Talk. Online status icons are displayed if you're signed in to Google Talk on your phone. For example,  means the contact is available to chat.

Setting up your profile

Store your personal contact information in **My profile** to easily send it to other people.

1. From the Home screen, tap  > **People**.
2. On the All tab, tap **Me**.





If you're logged in to your Facebook account through Facebook for HTC Sense, instead of **Me**, you'll see your Facebook name. Tap your name, press , then tap **Edit**.

3. Enter your name and contact details.
4. Tap **Save**.

Importing contacts from your SIM card

You can copy all your SIM contacts to your phone. Import them as phone contacts, Google contacts, or Exchange ActiveSync contacts, if you have set up the relevant accounts.

1. From the Home screen, tap  > **People**.
2. On the All tab, press , and then tap **Import/Export** > **Import from SIM card**.

3. If you have Google or Exchange ActiveSync accounts set up on your phone, tap the type for the imported contacts.
4. Do one of the following:
 - Tap one or more SIM contacts you want to import.
 - To import all contacts, press , and then tap **Select all**.
5. Tap **Save**.

Adding a new contact

1. From the Home screen, tap  > **People**.
2. On the All tab, tap **Add contact**.
3. Select the Contact type, for example Google or Microsoft Exchange ActiveSync. This determines which account the contact will sync with.





Some fields may not be supported when you're adding contacts to your SIM card.

4. Tap the **Name** field, enter the first and last name of the contact, then tap **OK**.
5. Enter the contact information in the fields provided. Press  if you want to close the onscreen keyboard first and easily scroll through the other fields.
6. Tap **Save**.

Importing a contact from an Exchange ActiveSync account

You can search for a work contact from your Exchange ActiveSync account, and then copy it on your phone.

You need to have your Exchange ActiveSync account set up on your phone first.

1. From the Home screen, tap  > **People**.
2. Press , and then enter the name.
3. Tap . Under Company contacts, matching names are listed.
4. Tap the name of the contact you want copied on your phone, and then tap **Save to People**.

Merging contact information

If you have the same contacts on your phone, Google Account, and social network accounts such as Facebook and Twitter, your phone will try to combine them automatically or let you decide which contacts to combine. Combining the same contacts avoids duplicated entries in your contacts list.

Accepting matched contacts suggestions

When your phone finds contacts that can be merged, you'll see a link icon  in the notifications area of the status bar.

1. Slide the Notifications panel down, and then tap **Matched contacts suggestion**. Your phone displays all suggested contacts that you can merge.

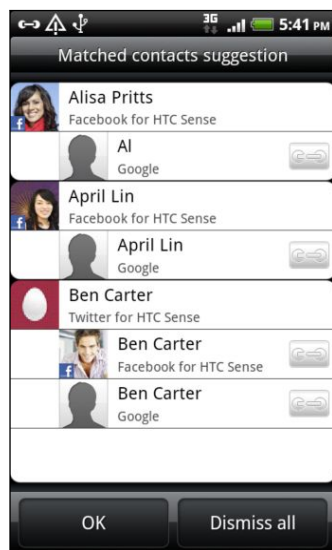



2. To merge, tap .
3. Tap OK.







If you don't want to merge any of your contacts, tap **Dismiss all**.



Viewing a list of all your linked contacts

1. From the Home screen, tap  > **People**.
2. On the All tab, press , and then tap **More > Linked contacts**. The All linked contacts screen then opens where you can see the account types and information merged.
3. You can choose to break the link of an account type or relink.
4. When you're done, tap **OK**.

Manually merging contact information



1. From the Home screen, tap  > **People**.
2. On the All tab, tap the name of the contact (not the icon or photo) you want to link.
3. On the upper-right corner of the screen, tap  or  (if there are suggested links).
4. On the screen, you can:
 - Under **Suggest links**, tap  to link the contact to an account.
 - Under **Add contact**, tap one of the options to link to another contact.
5. Tap **Done**.

Breaking the link



1. From the Home screen, tap  > **People**.
2. On the All tab, tap the name of the contact (not the icon or photo) whose link you want to break.
3. On the upper-right corner of the screen, tap .
4. Under the **Linked contacts** section, tap  beside an account type to break the link.
5. Tap **Done**.

Filtering your contacts list

After adding a new account to sync with your phone, you'll be asked whether to add contacts from that account the next time you open the People app. You can choose to only display contacts from particular account types (for example, Google contacts or Facebook contacts).

1. From the Home screen, tap  > **People**.
2. On the All tab, press , then tap **View**.
3. Select the types of contacts you want to show in your contacts list.
You can also choose how you want to display and sort your contacts.
4. Tap **Done**.

Searching for a contact



1. From the Home screen, tap  > **People**.
2. Press , then enter the first few letters of a contact's name. Matching contacts are displayed.
3. Tap the contact to open his or her contact details screen.

Backing up your contacts to the storage card

1. From the Home screen, tap  > People.
2. Press , and then tap **Import/Export** > **Export to SD card**.
3. Select an account or type of contacts to export, then tap **OK**.

Importing contacts from the storage card







You can only import contacts that were exported to the storage card using the **Export to SD card** feature on the phone.

1. From the Home screen, tap  > **People**.
2. Press , and then tap **Import/Export** > **Import from SD card**.
3. If you have Google or Exchange ActiveSync accounts set up on your phone, tap the type for the imported contacts.

Contact information and conversations

When you tap a contact on the People screen, the contact details screen opens, showing you the information you've stored or linked for that contact.

The contact details screen has the following tabs:

	<p>Details</p> <p>Shows the information you have stored for the contact. Get in touch with the contact directly by tapping any of the displayed methods. For example, if the contact has a stored work phone number, tap Call work.</p>
	<p>Messages</p> <p>Shows your exchanged SMS messages with the contact. You can reply to the contact's message directly from this tab.</p>
	<p>Mail</p> <p>Shows all the email you have received from the contact. Tap an email to view it.</p>
	<p>Updates and events</p> <p>Shows the contact's updates and events from social network accounts you've linked like Facebook, Twitter, and Flickr.</p>
	<p>Gallery</p> <p>Shows the linked contact's Facebook and Flickr albums and photos.</p>
	<p>Call History</p> <p>Lists all your incoming, outgoing, and missed calls to and from the contact.</p>

Editing a contact's information



1. From the Home screen, tap  > **People**.
2. On the All tab, press and hold the contact, and then tap **Edit contact**.



You cannot edit the contact information of a Facebook friend.

3. Enter the new information for the contact.
4. Tap **Save**.

Deleting contacts

1. From the Home screen, tap  > **People**.
2. On the All tab, press , and then tap **Delete**.
3. Select the contacts you want to remove, and then tap **Delete**.
4. When prompted, tap **OK**.

Sending contact information as a vCard

Easily share your own contact information or any contact on your phone.

1. From the Home screen, tap  > **People**.
2. On the All tab, do the following:

To send	Do this
Someone's contact information	Press and hold the name of the contact (not the icon or photo) whose contact information you want to send, and then tap Send contact as vCard .
Your contact information	<ol style="list-style-type: none"> 1. Tap [Your name] My profile. 2. Press , and then tap Send my profile.

3. Choose how you want to send it.

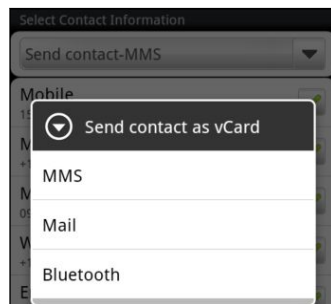

4. Select the type of information you want to send, and then tap **Send**.

Contact groups

Assign contacts to groups so you can easily send a message or email to a whole group. You can also sync groups on your phone with the groups in your Google account, accessible via your computer's web browser. We've also added the Frequent group as a special group type that automatically stores the contacts you dial or get calls from the most.

Creating a group



1. From the Home screen, tap  > **People**.
2. On the Group tab, tap **Add group**.
3. Enter a name for the group, and then tap **Add contact to group**.
4. Select the contacts you want to add to the group, and then tap **Save**.



If your contacts list is long, you can use the search bar to search for contacts quickly, or press  to hide the onscreen keyboard and scroll through the list.

5. Tap  to select a photo for the group.
6. Tap **Save**.

Editing a contact group

1. From the Home screen, tap  > **People**.
2. On the Group tab, press and hold the group, and then tap **Edit group**.
3. You can:
 - Tap the group name to change the name. You can only change the name for groups that you have created.
 - Tap the icon to the left of the group name to change or remove the group photo.
 - To add contacts to the group, tap **Add contact to group**, select the contacts you want to add, and then tap **Save**.
 - To remove a contact from the group, tap  at the right side of the contact name.
4. Tap **Save**.



Sending a message or email to a group



You will be charged by your mobile provider for each message sent. For example, if you send a message to a group of five people, you will be charged for five messages.

1. From the Home screen, tap  > **People**.
2. On the Group tab, tap the group you want to send a message or email to.
3. Go to the Group action tab, and then do one of the following:
 - Tap **Send group message** to send a message to the group.
 - Tap **Send group mail** to send an email to the group.

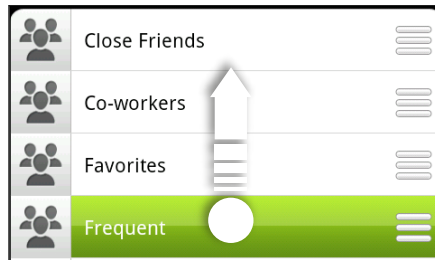

Rearranging your contact groups

1. From the Home screen, tap  > **People**.
2. On the Groups tab, press , and then tap **Rearrange**.
3. Press and hold  at the end of the group you want to move. When the row is highlighted, drag it to its new position.



4. Tap **Save**.

Rearranging the members of a contact group

1. From the Home screen, tap  > **People**.
2. On the Groups tab, tap the group to see its members.
3. Press , and then tap **Rearrange**.
4. Press and hold  at the end of the contact's name you want to move. When the row is highlighted, drag it to its new position.
5. Tap **Save**.

Deleting a group





You can only delete groups that you have created.

1. From the Home screen, tap  > **People**.
2. On the Groups tab, press and hold the group you want to delete, and then tap **Delete group**.

Adding People widgets

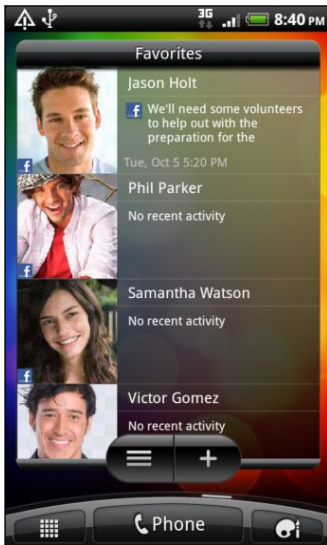
Stay in touch with different circles of friends or colleagues in your life. Using the People widget, you can instantly place a call, send a message, view details of a favorite contact, and even check Facebook and Twitter updates. You can add several People widgets on the Home screen, with a different group of contacts on each widget.



1. From the Home screen, tap  > Widget > People.
2. Choose the widget style, and then tap **Select**.
3. Select the group you want to add as a widget.
4. Drag the widget to a blank space on a Home screen. When the widget is where you want it, lift your finger.
5. Repeat the above steps to add another People widget.

Setting the default communication method

1. On the Home screen, go to the People widget.
2. Tap a contact on the widget.
3. On the Select default action screen, tap the communication method you want for the contact.

Changing the default communication method

1. On the Home screen, go to the People widget.
2. Tap the name of a contact on the widget to open the person's contact card.
3. Press , and then tap **More > Set default action**.
4. On the Select default action screen, tap the communication method you want for the contact.

Getting in touch with a contact

1. On the Home screen, go to the People widget.
2. Tap a contact (photo not the name) on the widget. The default communication method will be performed.



Tap the name of the contact to open the contact details screen for that contact.

Messages

Opening Messages

Keep in touch with important people in your life. Use the Messages app to compose and send text (SMS) and multimedia messages (MMS).

From the Home screen, tap  > **Messages**. The All messages screen opens, where all your sent and received messages are neatly grouped into conversations, by contact name or phone number.

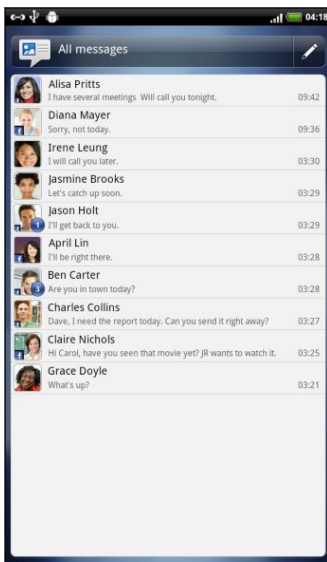



- Scroll up or down the list of conversations by swiping your finger on the screen.
- Tap a contact name or number to view the exchange of messages.



You can also view your messages on the Home screen with the Messages widget.

Sending a text message (SMS)

1. From the Home screen, tap  > **Messages**.
2. Tap .
3. Fill in one or more recipients. You can:
 - Enter the first few letters of a contact name or starting digits of a mobile number. As you type, matching names with phone numbers from your stored contacts are displayed. Tap a name or one of the contact's numbers.
 - Tap , and then select the phone numbers of the contacts to whom you want to send the message. You can also select contact groups as recipients.
 - Enter the complete phone numbers directly in the To field.

4. Tap the box that says **Add text**, and then enter your message.

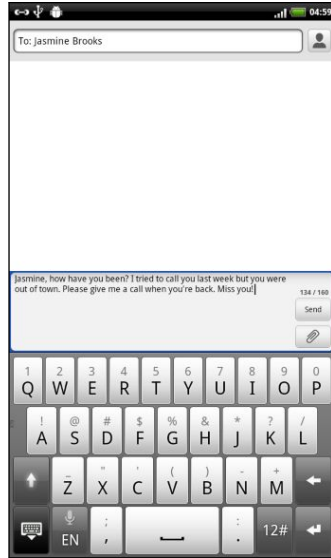

- There is a limit on the number of characters for a single text message (displayed above the **Send** button). If you exceed the limit, your text message will be delivered as one but will be billed as more than one message.
- Your text message automatically becomes a multimedia message if you enter an email address as the recipient, add a message subject, attach an item, or compose a very long message.

5. Tap **Send**, or press to save the message as a draft.

Sending a multimedia message (MMS)

1. From the Home screen, tap > **Messages**.
2. Tap .
3. Fill in one or more recipients. You can:
 - Enter the first few letters of a contact name or starting digits of a mobile number. As you type, matching names with phone numbers and email addresses from your stored contacts are displayed. Tap a contact's number or email address. Email addresses will be displayed when **Show email address** is selected in Recipient list settings.
 - Tap , and then select the phone numbers of the contacts to whom you want to send the message. You can also select contact groups as recipients.
 - Enter the complete phone numbers or email address directly in the **To** field.
4. To add a subject line, press and then tap **Add subject**.
5. Tap the box that says **Add text**, and then enter your message.

6. Tap  and then choose the type of attachment.

Picture	Take a photo and attach it, or attach an existing photo.
Video	Record a video and attach it, or attach an existing video.
Audio	Make a voice recording and attach it, or attach an existing audio file.
App recommendation	Choose an app you've installed from Android Market that you want to share with others. The URL from which the app can be downloaded will be inserted to your message.
Location	Add your current location (requires GPS to be turned on), or a location you pick on a map to your message.
Contact (vCard)	Select a contact, and then select the information to attach.
Appointment (vCalendar)	Select the calendar event you want to attach.







After adding an attachment, tap  to see options for replacing, viewing or removing your attachment.

7. Tap **Send**, or press  to save the message as a draft.

Creating a slideshow

- After you've added either a photo, video, or audio in the multimedia message you're composing, tap  > **Slideshow**.
- Do any of the following:

Add a slide	Tap  , and then choose to add a photo or a video.
Add music or a voice recording to a slide	Right after adding a slide, tap  > Audio .
Add a caption to a slide	Tap Add text and then enter your caption.
Edit a slide	Tap  , and then choose to replace, remove, or set the duration of the slide.
Preview the slideshow	Press  , and then tap Preview (or More > Preview). Tap once on the preview screen to see playback controls.

3. When finished, tap **Send**, or press  to save the message as a draft.

Resuming a draft message

1. On the All messages screen, press , and then tap **Drafts**.
2. Tap the message and then resume editing it.
3. Tap **Send**.

Viewing and replying to a message

Depending on your notification settings, HTC Flyer plays a sound, vibrates, or displays the message briefly in the status bar when you receive a new message. A new message icon  is also displayed in the status bar.



1. To open and read the message, you can:
 - Press and hold the status bar, and then slide your finger down to open the Notifications panel. Then tap the new message notification.
 - Open the Messages app to access and read the message.
2. While reading the message, you can:

Reply with a text message	Tap the box that says Add text , enter your reply message, and then tap Send .
Reply with a multimedia message	Tap the box that says Add text , enter your reply message, tap  to choose an attachment for your message, and then tap Send .
Send to or save a phone number contained in the message	Tap the phone number and then choose whether to send a text message or save it to a contact.
Open a link in the message	Tap the link to open it in the web browser.

Send to or save an email address contained in the message	Tap the email address. Then choose whether to send an email, send a multimedia message, or save the email address to your contacts.
Choose what to do with the message	Tap a message to open the options menu, and then choose what you want to do with the message, such as forward it, view message details, share, and more.

Replying to another phone number of the contact

When a contact has multiple phone numbers stored on HTC Flyer, you'll see the particular phone number used within the message. There's also a bold letter before the phone number to indicate the number type (for example, **M** stands for **Mobile**).

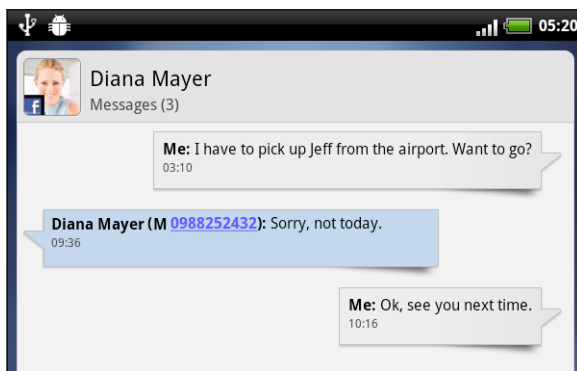

Keep in mind that your response will be sent to the phone number of the latest message you've received from this contact.

1. On the All messages screen, tap a contact (or phone number) to display the exchange of messages with that contact.
2. Tap the box that says **Add text**, then enter your reply message.
3. Press  and then tap **More > Recipient phone number**.
4. Select another phone number of this contact, and then tap **OK**.

Previewing message conversations

While you're browsing through the list of conversations on the All messages screen, you can preview the exchange of messages with a contact or phone number.

- Turn HTC Flyer to the left and hold it in landscape orientation to see a split-window preview, with the conversation list on the left and the exchange of messages with a contact or phone number on the right.



- While previewing the exchange of messages, scroll down to the bottom and then tap the box that says **Add text** if you want to send a reply. Enter your reply and then tap **Send**. After sending, press  to return to the split-window preview.

Viewing and saving an attachment from a multimedia message

If you are concerned about the size of your data downloads, check the multimedia message size first before you download it.



When **Auto-retrieve** in MMS settings is disabled, only the message header is downloaded. To download the entire message, tap the **Download** button at the right side of the message.

- If there's a media attachment such as a photo or video in a received message, tap it to view the content.
- If the attachment is a contact (vCard), tap it to view the contact information, then tap **Save** to add to your contacts.
- If the attachment is an appointment or event (vCalendar), tap it to choose the calendar where to save it, and then tap **Import**.
- To save the attachment to your storage card, press and hold the multimedia message, and then choose to save the type of attachment from the options menu.

Push messages



Push messages contain a web link. Often, the link will be to download a file that you have requested from your service provider.

When you receive a push message, a notification icon  is displayed in the status bar.

Opening and reading a new push message

1. Press and hold the status bar, and then slide the status bar down to open the Notifications panel.
2. Tap the new message.
3. Tap **Visit website**.

Viewing all your push messages

1. From the Home screen, tap  > **Messages**.
2. Press , and then tap **Push messages**.



You can only see this option if you've previously received push messages.

Managing message conversations

Protecting a message from deletion

You can lock a message so that it will not be deleted even if you delete the other messages in the conversation.

1. On the All messages screen, tap a contact (or phone number) to display the exchange of messages with that contact.
2. Tap the message that you want to lock.
3. Tap **Lock message** on the options menu. A lock icon  is displayed at the right hand side of the message.

Copying a message to your SIM card

1. On the All messages screen, tap a contact (or phone number) to display the exchange of messages with that contact.
2. Tap the message, and then tap **Copy to SIM**. A SIM card icon  is displayed at the right hand side of the message.

Deleting a single message

1. On the All messages screen, tap a contact (or phone number) to display the exchange of messages with that contact.
2. Tap the message that you want to delete.
3. If the message is locked, tap **Unlock message** on the options menu, and then tap the message to display the options menu again.
4. Tap **Delete message** on the options menu.
5. When prompted to confirm, tap **OK**.

Deleting several messages within a conversation

1. On the All messages screen, tap a contact (or phone number) to display the exchange of messages with that contact.
2. Press  and then tap **Delete** (or **More > Delete**).
3. Tap **Delete by selection**.



You can also tap **Delete by phone number** if the contact used multiple phone numbers throughout the conversation and you want to delete the messages sent from a particular number.

4. Select the messages you want to delete and then tap **Delete**.

Deleting a conversation

- Do any of the following:
 - On the All messages screen, press and hold a contact (or phone number) whose messages you want to delete, and then tap **Delete**
 - While looking at the exchange of messages in a conversation, press  and then tap **Delete > Delete thread** (or **More > Delete > Delete thread**).

Any locked messages in the conversation thread will not be deleted unless you select the **Delete locked messages** check box.
- When prompted to confirm, tap **OK** to delete the entire thread.

Deleting several conversations

- On the All messages screen, press  and then tap **Delete**.
- Select the conversation threads you want to delete.
- Tap **Delete**. Any locked messages will not be deleted.

Setting message options

On the All messages screen, press  and then tap **Settings**.

Notifications	<ul style="list-style-type: none"> Receive a notification in the status bar and set HTC Flyer to vibrate or play a sound when a message arrives or when a message is not sent successfully, and choose a notification sound. Allow HTC Flyer to show pop-up notifications on the screen when messages are sent successfully or not, or disable this option.
Text messages (SMS)	<ul style="list-style-type: none"> Receive a report on the delivery status of your message. View or change the message service center number used. (We recommend that you don't change the number here as it may cause problems in receiving and sending messages.) View or delete text messages stored on your SIM card, or copy SIM card messages to device memory.

Multimedia messages (MMS)

- Receive a report on the delivery status of your message.
- Receive a report whether each recipient has read the message or deleted it without reading.
- Automatically download complete MMS messages including the message body and attachments in your service area and when roaming.
- Set the message priority and maximum file size of MMS messages. If the MMS message file size is exceeded, the message won't be sent.

General

- Search and display the sent message history, call history, and email addresses of stored contacts when you're adding message recipients.
- Choose the maximum number of text or MMS messages to store in each conversation thread (excluding locked messages), and enable automatic deletion of unlocked older messages when set limits are reached.
- Forward received text and MMS messages to another phone number or email address. (This may incur extra fees from your mobile operator.)

Market and other apps

Finding and installing apps from Android Market

Android Market is the place to go to find new apps for HTC Flyer. Choose from a wide variety of free and paid apps ranging from productivity apps, entertainment, to games.



Paid apps are currently only available in certain countries.

Finding and installing an app



When you install apps and use them on HTC Flyer, they may require access to your personal information or access to certain functions or settings. Download and install only apps that you trust.



Be cautious when downloading apps that have access to functions or a significant amount of your data on HTC Flyer. You're responsible for the results of using downloaded apps.

You need a Google Checkout account to purchase items on Android Market.

1. From the Home screen, tap  > **Market**.
2. Do any of the following to find an app:

Browse featured apps	Scroll through the list of featured apps.
Browse apps by categories	Tap Apps or Games , and then tap a category. Under a category, you can filter the apps by Top paid , Top free or Just in .
Search for an app	Tap  , enter the name or type of app you're looking for, and then tap  .

3. When you find the app that you like, tap it and read its description and user reviews.



4. To download or purchase the app, **FREE** (for free apps) or the price button under **Buy** (for paid apps).
5. If you agree to the conditions, tap **OK** to begin downloading and installing the app.



You can uninstall an app for a refund within a limited time after your purchase. To know more about the refund policy for paid apps, please visit the Android Market Help site (<http://market.android.com/support>).

Opening an installed app

Do one of the following:

- If you see this icon  on the status bar, open the Notifications panel, and then tap the app.
- From the Home screen, tap  > **Market** > **My apps**. On the My apps screen, tap the app, and then tap **Open**.
- From the Home screen, tap . On the All apps screen, slide to the Downloaded tab, and then tap the app.

Uninstalling an app

You can uninstall any app that you have downloaded and installed from Android Market.

1. From the Home screen, tap  > **Market** > **My apps**.
2. Tap the app you want to uninstall, and then tap **Uninstall**.
3. When asked, tap **OK**.
4. Choose the reason for removing the app, and then tap **OK**.

Getting help

If you need help or have questions about Android Market, press , and then tap **Help**. The web browser will take you to the Android Market Help site.

Using the Clock

About the HTC Clock widget

Use the HTC Clock widget to see your current date, time, and location. You can also use the Clock to show the time in another city.



Changing the location on the Clock widget

By default, the Clock widget displays your current weather. You can customize the Clock widget on your Home screen to show the weather of another location.

1. Press and hold the Clock widget and then drag it to the edit button .
2. Choose a city.



You can add more than one Clock widget to the extended Home screen. Choose from a variety of looks and designs and select the city to display.

Using the Clock app

Get more from the Clock app than just the regular date and time. Use HTC Flyer as a desk clock complete with weather information or as a world clock so you can see what time it is in several cities across the globe. You can also use it as an alarm clock, stopwatch, and countdown timer.



To open the Clock app, do one of the following:

- Tap the Clock widget on the Home screen.
- From the Home screen, tap  and then tap **Clock**.

Tap the tabs on the bottom row or slide your finger across the tabs to switch between the different functions of the Clock app.

Using Desk Clock

The Desk Clock displays the current date, time, and weather. It also shows an alarm clock indicator, the battery level, and your upcoming calendar events.

- Tap the weather image or information to open the Weather app where you can see weather forecasts for the next few days.
- Tap  to dim the screen slightly on the Desk Clock.
To light up the screen again, tap anywhere on the screen.
- Tap  to dim the screen completely and go into screensaver mode.
When in screensaver mode, the Desk Clock shows the time and date only and their position changes on the screen every few minutes. To light up the screen again, tap anywhere on the screen.
- Turn power saving mode on or off by selecting or clearing its check box.
- If you have several upcoming calendar events, scroll down the list to check your events.

Using World Clock

Use the Clock app's World Clock tab to check the current time in several places around the globe simultaneously. You can also set your home city, add more cities to the world clock list, and manually set your time zone, date, and time.

Setting your home city

1. On the World Clock tab, press  and then tap **Home settings**.
2. Enter your home city's name. As you enter letters, the list is filtered to show matching cities and countries.
3. Scroll through the list and tap your home city.

Setting the time zone, date, and time

To set the time zone, date, and time on HTC Flyer manually, you need to turn off auto time sync first.

1. On the World Clock tab, press  and then tap **Local time settings**.
2. Clear the **Automatic** check box, and then set the time zone, date, and time as required.



From the Home screen, you can also press  and then tap **Settings > Date & time** to open the Date & time settings screen.

Adding a city to the World Clock screen

Add more cities to the World Clock screen so you can instantly check the date and time in these cities.

1. On the World Clock tab, tap .
2. Enter the city name you want to add. As you enter letters, the list is filtered to show matching cities and countries.
3. Scroll through the matching list and tap the city that you want to add.

Setting an alarm

You can use the Clock app's Alarms tab to set up one or more wake-up alarms.

1. On the Alarms tab, select the check box of an alarm.
2. Under Set alarms, drag your finger up or down to roll the time scroll wheels and set the alarm time.
3. Choose from the available options. You can:
 - Enter the alarm **Description** and choose the **Alarm sound** to use.
 - Tap **Repeat**. Select which days of the week to sound the alarm, and then tap **OK**.
 - Select the **Vibrate** check box if you want HTC Flyer to also vibrate when the alarm goes off.
4. After you've finished setting the alarm, tap **Done**.



- To turn off an alarm, clear the check box of that alarm.
- If you need to set more than three alarms, tap .

Deleting an alarm

1. On the Alarms tab, press  and then tap **Delete**.
2. Select the alarms you want to delete and then tap **Delete**.

Changing alarm sound settings

On the Alarms tab, press  and then tap **Settings**. You can change the following settings:

Alarm in silent mode	Selected by default, this option allows the alarm to sound even when the volume is set to silent. Clear this check box if you want to silence the alarm when HTC Flyer is in silent mode.
Alarm volume	Set the volume level that you want for the alarm.

Snooze duration	Set how long to snooze between alarms.
Side button behavior	Choose what happens to the alarm when pressing the side button (VOLUME UP/VOLUME DOWN). You can set the button to snooze, dismiss the alarm, or disable the button. The side button works only when the screen is not locked.

Checking Weather



Use the Weather app and widget to check the current weather and weather forecasts for the next few days. In addition to your current location, you can view weather forecasts for other cities around the globe. Your settings in the Weather app also control the weather information that is shown in the Clock and Calendar.





For HTC Flyer to detect your current location and display your local weather in the Weather app and widget as well as in Clock and Calendar:

- You need to turn on and use Wi-Fi or the mobile network to connect to the Internet.
- Location services must be enabled. If you didn't enable it when you first set up HTC Flyer, you can do so in **Settings > Location**.

1. From the Home screen, tap  > **Weather**.

You'll see a full screen animation of your current weather and weather information such as the temperature, approximate time of sunset, and more. While in full screen view, tap  or  to check the weather in other cities.



2. Tap  to view more information. You can check weather forecasts for the current day and the upcoming days.
3. While viewing forecasts, you can:
 - Swipe your finger up or down the list of cities, and then tap a city to view its weather forecasts.
 - Tap  to update the weather information at any time.
 - Tap **More details online** to see more weather details on the Web.

Adding a city to the Weather screen

Add more cities to the Weather screen so you can instantly check the weather forecasts in these cities. In addition to your current location, the Weather screen can display up to fifteen cities.

1. On the Weather screen, tap .
2. Enter the location you want to add. As you type, the list is filtered to show the possible locations based on the letters you entered.
3. Tap the desired city to select it.

Changing the order of cities on the Weather screen

1. On the Weather screen, press  and then tap **Edit**.
2. Press and hold  at the end of the item you want to move. When the row is highlighted in green, drag it to its new position, then release.
3. Tap **Done**.

Deleting cities from the Weather screen

1. On the Weather screen, press  and then tap **Edit**.
2. Select the cities you want to remove and then tap **Done**.

Changing Weather options

1. On the Weather screen, press  and then tap **Settings**.
2. You can change the following weather settings:

Update when opened	Select this check box to refresh weather updates every time you open the Weather app.
Scheduled sync	Select this check box to automatically download weather updates.
Update schedule	Set an auto update schedule.
Temperature scale	Choose whether to display the temperature in Celsius or Fahrenheit.
Sound effects	Choose whether to play sound effects related to the weather conditions.

About the Weather widget



Use the Weather widget to instantly check weather forecasts of your current location and other cities without having to open the Weather app. The Weather widget comes in different looks and styles.

You can add this widget to the Home screen, if it's not yet added.





Reading eBooks

Start your own library of bestsellers and literary classics right on HTC Flyer. Use the Reader app to read and download eBooks from Kobo, an online bookstore.

We've included some eBooks for you to try. To browse for more titles from Kobo, you need to be connected to the Internet.

1. From the Home screen, tap  > **Reader**. On the Reader main screen, you'll find thumbnails of your recently read and downloaded eBooks.
2. Slide your finger left or right across the screen to browse through the available eBooks. You can also tap  to browse through these eBooks in list view.

3. Tap an eBook to open it.
4. Slide your finger left or right to flip through pages in the eBook.
5. To zoom in or out, spread or pinch your thumb and index fingers across the page.
6. To view in landscape, turn HTC Flyer sideways.
7. Tap anywhere on the screen to use these controls:

	Quickly jump between chapters by dragging the slider.
	View the table of contents and your bookmarked pages. You can also see the notes and highlights that you've marked in the eBook.
	Add a bookmark.
	Change the font size.
	Search for keywords or phrases.

8. When you're done reading, press  to close the eBook.



When you reopen an eBook, it will take you to the page that you last viewed.

Adding a note or highlighting selected text

Spotted an interesting quote or a less-known fact? Take note or highlight it.

1. Press and hold on a word, and then drag the start and end markers to select the surrounding text.

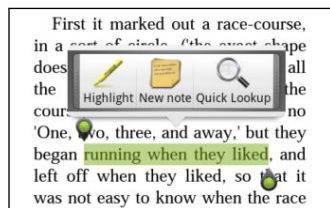

2. On the popup bar:

Tap	To
Highlight	Mark the selected text with your choice of color.
New note	Add a short comment or remark.

Viewing notes and highlights you've created







1. Tap anywhere in the eBook you're reading, and then tap .
2. Go to the Notes tab or Highlights tab to view the information that you want.

Downloading an eBook

Browse the bookstore and choose from hundreds of available titles to download.

You need to have:

- an active Wi-Fi or data connection
- a Kobo account and an Adobe® ID account. If you don't have these accounts yet, either sign up from your phone or from your computer's web browser. (On your computer, go to: www.kobobooks.com/signup.html and www.adobe.com/cfusion/membership/index.cfm.)

1. If you have not yet logged in to Kobo and Adobe ID accounts, press , and then tap **Accounts** to sign in.
2. On the Reader main screen, tap .
3. In the eBooks by Kobo tab, do any of the following to find a book:
 - Tap a category to see available book titles.
 - View more categories. Press , and then tap either **Browse** or **Discover**.
 - Tap  to find a specific book title or author.
4. Tap the eBook you want to download. You'll then see information such as the eBook's price, its summary and ratings.
5. Tap  to place your order.
6. Provide your purchase details, and then tap **Buy**.
7. Tap  to download the eBook. When downloading is complete, you'll find the eBook in your library.



- After you've used Kobo once to purchase an eBook, your phone remembers your billing details so you don't need to enter them the next time.
- If you've previously bought eBooks from Kobo using your computer, go to the Available for download tab in Reader to download them to your phone.

About the My Shelf widget

Use the My Shelf widget to easily open your eBooks for reading right from your Home screen.



Reading news feeds

Don't get left behind with yesterday's stories. Use the News app to subscribe to news feeds that cover breaking news, sports, top blogs, and more. You can also get updates based on specific keywords.

Subscribing to news channels



You need to be signed in to a Google Account before using the News app.



1. From the Home screen, tap  > **News**.
2. Tap , and then tap **Subscriptions > Add feeds**.
3. Do one of the following:
 - Tap a category such as **Blogs** or **Entertainment** to choose from popular news feeds.
 - Tap **Search more** to search for a specific keyword or feed URL.
4. After selecting the channel or channels to subscribe to, tap **Add**.



To manually update news stories on your channels, press , and then tap **Refresh**.



Adding a keyword



Easily find stories that interest you by entering a search keyword.

1. From the Home screen, tap  > **News**.
2. Tap , and then tap **My items > Keywords > Add keywords**.
3. Enter the keyword, and then tap **Add**. Your new keyword is displayed under the Keywords list.
4. Tap the keyword to show the stories that contain that keyword.

Reading a story

1. From the Home screen, tap  > **News**.
2. On the Subscriptions tab, tap a channel.
3. Tap a story to read it. While reading the story, you can:

Tap	To
	Star the story as a favorite.
	Share a link to the story from the available options.

Tap	To
	Go to the web page where the story is published.
	Go to the next or previous story in the channel.

- If you want to read the whole story, tap **Read full article**. This opens the story in the web browser.

Changing update schedule and content settings

While on the News app, press  > **Settings**, and then tap any of the following:





Accounts & sync	Manage sync options and general News settings.
Update when opened	Update the content of the channels you've subscribed to every time you open the News app.
Update schedule	Choose a time interval when the channels you've subscribed to are updated. Select Manual to refresh the content only when you like.
News content	Choose how to read news stories by default: whether as a summary or as a full web page article.
Mobile view	If you've selected to view the news content as a web page article, choose to display web page articles optimized for mobile viewing.

About the News widget

Use the News widget to read snippets of stories that you've subscribed to right from your Home screen.

Keeping track of your stocks



Use the Stocks app to get the latest stock updates for stock quotes and market indices you follow.

1. From the Home screen, tap  > Stocks.
2. On the Stocks main screen, do any of the following:
 - Tap an item to view from the list of stock quotes and market indices.
 - Tap  to update the stock information.
 - Tap  to add a stock quote or stock market index.
 - To change the stock list order, press , and then tap **Rearrange**. Press and hold  at the end of the item you want to move, then drag it to its new position.
3. When you've selected a particular stock quote or stock market index, you can:



- View an item's trade information as well as its price chart for a specific period.
- Slide to other tabs to view up to two years of an item's past trade information.

Adding a stock quote or stock market index

1. On the Stocks main screen, tap .
2. Enter the stock quote or stock market index on the text field, and then tap .
3. Tap the stock quote or stock market index you want to add.



To delete an item, press  while on the Stocks main screen, and then tap **Delete**. Select the items you want to delete, and then tap **Delete**.

Changing update schedule and color settings



Downloading stock information automatically may incur additional fees from your mobile operator.

On the Stocks main screen, press , and then tap **Settings**. Do any of the following:



Tap	To
Update when opened	Update the stock information every time you open the Stocks app.
Scheduled sync	Set automatic downloads of stock information.
Update schedule	Choose a time interval for checking updates.
Set color for price raise	Change the color for displaying stock price increases to either red or green, depending on what's being used in your country.

About the Stocks widget



Use the Stocks widget to instantly check stock updates right on your Home screen.

Watching videos on YouTube

Use the YouTube app to check out what's popular on the online video-sharing website.

1. From the Home screen, tap  > **YouTube**.
2. Scroll through the list of videos, and then tap a video to watch it.
3. While watching a video, you can:
 - Turn your phone sideways or double-tap the screen to watch the video in full screen.
 - Tap the video screen to pause, resume playback, or drag the slider to jump to a different part of the video.
 - Tap a tab to learn more about the video, see related videos, or check out what other viewers think. You can also slide your finger across the tabs to see if there are more items available.
 - Tap the thumbs-up or thumbs-down icon to add your video rating. Tap **More** to see other options.
4. Press , and then tap **Home** to return to the YouTube main screen.

Searching for videos

1. On the YouTube main screen, press .
2. Enter a search keyword, and then tap .
3. Scroll through the results and tap a video to watch it.



You also have the option to show results that were just recently posted. Tap **All time**, and then select a time period you want.





Clearing the search history

1. On the YouTube main screen, press , and then tap **Settings**.
2. Tap **Clear search history**, and then tap **OK** when prompted.

Sharing a video link

1. On the video's watch screen, tap **More > Share**.
2. Choose how you want to share the video link from the available options.

Capturing and sharing videos on YouTube



1. From the Home screen, tap  > **YouTube**.
2. Tap .
3. Tap  to start capturing video.
4. When you are done capturing, tap  again.
5. Enter a title, description, and tags for your video.
6. Set the privacy level.
7. Tap **Upload**.

Sharing games and apps

Having fun with a game or app that you found from Android Market? Share your favorite games and apps instantly with your circle of friends.





For your friends to link to the app and download it from Android Market, they must be using an Android phone.

1. From the Home screen, tap .
2. Press , and then tap **Share**. You'll then see the list of games and apps that you downloaded and installed from Android Market.
3. Tap an app, and then choose how to share it.

When your friends see the link in your sent message, email, or status update, they can simply tap the link to go directly to the game or app in Android Market to download it.



- While entering your status update in Friend Stream, you can also tap  to choose from games or apps that you want to share in your social networks.
- If you've already created a new text or email message, press  and then tap **Attach > App recommendation** to choose from your list of installed games and apps.

HTC Sync

About HTC Sync

You have your new vacation photos on HTC Flyer while your business calendar is on your computer. Why not make these types of files and information available on both devices?

With HTC Sync, you can:

- Sync your contacts between your Microsoft Outlook, Outlook Express or Windows Contacts on your computer and HTC Flyer.
- Sync your calendar events between the Outlook or Windows Calendar on your computer and HTC Flyer.
- Bring your photos, videos, documents, songs, and playlists to HTC Flyer and enjoy them on the go.
- Easily import your captured photos and videos from HTC Flyer to your computer.
- Store the same bookmarks on both your computer and HTC Flyer web browsers.
- Use your computer's Internet connection to download maps and useful add-on services for the Locations app.
- Install third-party mobile phone apps (not downloaded from Android Market) from your computer.



- You need a storage card inserted into HTC Flyer to be able to sync multimedia files, maps, and documents.
- The available categories and options depend on the device you've connected to your computer.

Installing HTC Sync that came with the storage card

Copy the HTC Sync installer from the storage card to your computer and use it to install.



- The HTC Sync version in the storage card that came with your phone can be installed on a computer running Windows 7, Windows Vista, or Windows XP.
- HTC Sync requires USB 2.0 on your computer to connect and sync with your phone.
- For trouble-free installation, first quit all running programs and temporarily exit from your anti-virus program before you start installing HTC Sync.

1. Connect your phone to your computer using the supplied USB cable.
2. On your phone's Connect to PC screen, tap **Disk drive**, and then tap **Done**. On your computer, the connected phone is recognized as a removable disk.
3. Navigate to the removable disk and open it.
4. Copy **HTCSync.exe** to your computer.
5. After copying, unmount the removable disk (that is, the connected phone) as required by your computer's operating system to safely remove your phone.
6. On your computer, double-click **HTCSync.exe** and follow the onscreen instructions to install HTC Sync.

After installing HTC Sync, the HTC Sync icon  is added to your computer's system tray (check the bottom-right side of your computer screen). You can double-click this icon to open HTC Sync.

Setting up HTC Sync to recognize your phone

1. Connect your phone to your computer using the USB cable that came with your phone.
2. When your phone prompts you to choose a type of USB connection, tap **HTC Sync**, and then tap **Done**. Wait for HTC Sync to recognize your phone.
3. On the Device setup screen, enter a name for your phone.
4. Click **Save**. The Device panel then opens.



To change the name of your phone later, click **Overview > Device setup**.

Getting to know the workspace

On the Device panel, you can set your sync options, see your phone's general information, check the used and available space on your storage card, and begin synchronization.



The available categories and options depend on the phone you've connected to your computer. For example, Locations appears in the Device panel when you have the Locations app on your phone.

- You can click a category of items to see its sync options on the right side of the Device panel.

Clicking **Overview** displays your phone's basic software information and storage card usage, change the phone name, or install third-party applications to your phone.

- The **Sync now** button lets you start syncing the categories and options you've selected.
- The estimated storage usage bar beside the **Sync now** button shows you the estimated storage card space that will be used when there are new items to be synchronized and added to your phone.

Setting up synchronization

You can choose the types of files and information you want to sync between your phone and computer.

Music sync options

Bring the music tracks and songs you play on your computer to your phone. If you have playlists created in iTunes® or Windows Media® Player, you can sync these too and enjoy them on the go.



You can sync audio files in these formats: *.aac, *.amr, *.m4a, *.mid, *.midi, *.mp3, *.wav, *.wma

1. On the Device panel, click Music, and then click the **On** button. Turning Music sync on means you want this category included every time you sync your computer and phone.
2. Select **Sync music files from**, and then click **Add**.
3. Choose a folder that contains your audio files, and then click **OK**.
4. Select **Sync music files from iTunes and Windows Media Player** if you're using iTunes or Windows Media Player on your computer, then choose the playlists you want to sync on your phone.

Gallery sync options

You can automatically sync photos and videos between your phone and computer.



You can sync audio files in these formats:

- Photos: *.bmp, *.gif, *.jpeg, *.jpg, *.png
- Videos: *.3gp, *.3g2, *.mp4, *.wmv

1. On the Device panel, click **Gallery**, and then click the **On** button. Turning Gallery sync on means you want this category included every time you sync your computer and phone.
2. To automatically import your camera shots to your computer during synchronization, select **Copy device Camera Shots to PC**. Photos and videos from your storage card will be saved to the \My Photos\Device Camera Shots folder on your computer.
3. Select **Sync PC photos & videos from**, and then click **Add**.
4. Choose a folder that contains your multimedia files, and then click **OK**. All supported image and video files added to this folder will be copied to your phone's storage card during synchronization.

Calendar sync options

Your phone can sync appointments and events with your calendar in Outlook (Outlook XP, Outlook 2003 or Outlook 2007) or Windows Calendar.

1. On the Device panel, click **Calendar**, and then click the **On** button. Turning Calendar sync on means you want this category included every time you sync your computer and phone.
2. Select the application you want to sync calendar events with.
3. Choose from which point you want to start synchronizing your calendar events.
4. In cases when conflicting information is found on both the phone and computer, choose which information you want to keep.



Only the calendar fields supported on your phone will be synchronized.

People sync options

Sync your phone contacts with your Outlook (Outlook XP, Outlook 2003 or Outlook 2007), Outlook Express, or Windows Contacts.

If you have contacts to sync from your SIM card, you have to import these first to your phone storage.

1. On the Device panel, click **People**, and then click the **On** button. Turning People sync on means you want this category included every time you sync your computer and phone.
2. Choose the application you want to sync your contacts with.
3. In cases when conflicting information is found on both the phone and computer, choose which information you want to keep.



Only the contact fields supported on your phone will be synchronized.

Bookmarks sync options

Sync web browser bookmarks between your phone and computer.



If you are using Google Chrome or Firefox Internet browser and have selected it to sync with your phone, make sure to close all browser windows before you begin synchronization.

1. Using your favorite web browser on your computer, create a favorites folder named **HTC bookmarks**. Make sure to save your favorite bookmarks in this folder to be able to sync them with your phone.
2. On HTC Sync's Device panel, click **Bookmarks**, and then click the **On** button. Turning Bookmarks sync on means you want this category included every time you sync your computer and phone.
3. Choose the web browser that stores the bookmarks to sync with your phone.



When conflicting information is found on both the phone and computer, HTC Sync keeps the information from your computer.

Documents sync options

You can sync files and documents from your computer to your phone. You can also sync email attachments that you stored on your phone's storage card to your computer.



- To open a document on your phone, you'll need a compatible app. Usually, your phone can open and view these file types: Microsoft Office 2003 and 2007 Word (*.doc), Excel (*.xls), and PowerPoint (*.ppt), PDF files (*.pdf), text files (*.txt).
- To sync email attachments stored on your phone's storage card to your computer, you must set up an Exchange ActiveSync or POP3/IMAP email account from the Mail app on your phone.

1. On the Device panel, click **Documents**, and then click the **On** button. Turning Documents sync on means you want this category included every time you sync your computer and phone.
2. To sync email attachments that you've stored on your phone's storage card, select **Copy all download Mail documents to PC**.
3. Select **Sync PC documents from**, and then click **Add**.
4. Choose a folder that contains the documents you want to sync on your phone, and then click **OK**.

Email attachments from your phone's storage card will be saved to the \My Documents\Device documents\ folder on your computer. Documents from your computer will be saved to the \My Documents\Device documents\ folder on your storage card.

Locations sync options

Before going on a trip to another city or country, you can download the maps you need using HTC Sync on your computer, then sync them to your phone. You can also purchase licenses for other useful data such as driving and walking navigation, safety cameras alerts, and more.

1. On the Device panel, click **Locations**, and then click the **On** button. Turning Locations sync on means you want this category included every time you sync your computer and phone.
2. Select and download maps and additional map features. To find out how, see [Downloading maps or purchasing services](#) on page 169.
3. After you're done downloading items on your computer, you'll see these items in the Locations content list. You can then choose whether you want to sync all maps and licenses or just the items you select.

<input type="checkbox"/> Item	Size	Type
<input checked="" type="checkbox"/> Argentina	3.69 KB	Navigation
<input type="checkbox"/> Benelux	0.23 MB	Safety cameras
<input checked="" type="checkbox"/> New Zealand	1.95 KB	Navigation
<input checked="" type="checkbox"/> Taiwan	0.15 MB	Safety cameras
<input type="checkbox"/> United Kingdom and Ireland	2.16 KB	Navigation
<input type="checkbox"/> Western Europe	11.03 KB	Navigation

Synchronizing your phone

Check the estimated usage bar beside the **Sync now** button for the estimated file size of new items to sync on your phone.



When there's not enough space left on your storage card, you'll see a warning icon and you won't be able to sync.

1. After selecting and customizing the categories you want to sync, click **Sync now**.
2. After synchronization is complete, click **Disconnect**.
3. Safely remove your phone as required by your computer's operating system.

The next time you connect your phone to your computer, synchronization automatically begins based on your sync settings.

Installing an app from your computer to your phone

If you have application files (*.apk) on your computer, you can use HTC Sync to install them to your phone. We strongly recommend you install only applications that you trust.



Before you begin, make sure that your phone is set to allow applications from your computer to be installed to your phone. To do this, press  while on the Home screen, tap **Settings > Applications**, and then select the **Unknown sources** check box.

1. On the Device panel, click **Overview**.
2. Click **Application installer**.
3. Browse for the application file on your computer, and then click **Open**. The installation process starts on your phone.
4. Check your phone's screen to see if there are additional instructions to complete the installation.
5. After installation is complete, you can click **Disconnect**.
6. Safely remove your phone as required by your computer's operating system.

Downloading maps or purchasing services

You can download maps for free or purchase premium services such as navigation, safety cameras, and turn-by-turn voice instructions.

1. On the Device panel, click **Locations**, and then click the **On** button.
2. Click **Get more Maps and Licenses**.
3. On the left side of the Navigation store window, click the type of content you want to download, and then select a country.
4. Under the Additional map features section, you can choose one or more navigation products you want to download or purchase. When purchasing navigation products, you also need to consider the license duration for using the downloaded content.
5. Click **Add to Shopping cart** .

Checking out products or licenses

1. Click **Add to Shopping cart**  beside **Navigation store** to view your shopping cart.
2. Review the items you've selected and the total amount of purchase.
3. Click **Check out**.

4. Enter your email address and your billing information (if you selected a premium navigation product).
5. Please take time to review the agreement, and then click **I agree to the terms and agreement** to continue.
6. Click **Review purchase** to see a list of items you've selected, your email address, and the billing information you've provided.
7. When everything is correct, click **Confirm and download**. The download progress of your selected maps will then display in the Device panel.

Synchronizing another phone with your computer

You can switch from one phone to another, if you have more than one device to sync.

1. Connect another phone to your computer, then set up HTC Sync to recognize this phone.
2. Click the phone you want to set up or begin synchronization. The Device panel then opens, where you can separately customize your sync settings for this phone.

To switch to another phone to sync, click **Devices**, and then click the phone's name or image.



Downloading the latest HTC Sync upgrade

Visit the HTC support website (www.htc.com/support/) from time to time to check for the most recent HTC Sync upgrade so you can download and install it on your computer.

After installing the latest upgrade, set up HTC Sync again to recognize and sync with your phone.

Keyboard

Using the onscreen keyboard

When you start an app or select a field that requires text or numbers, the onscreen keyboard becomes available. After entering your text, you can tap  or press  to close the onscreen keyboard.

Selecting a keyboard layout







You can choose from three different keyboard layouts to suit your typing style.

1. From the Home screen, press , and then tap **Settings** > **Language & keyboard** > **Touch Input**.
2. Tap **Keyboard types**, and then select the keyboard layout that you want to use. Choose one from the following:

QWERTY	This layout is similar to a desktop computer keyboard. This is the default keyboard layout.
Phone Keypad	This layout resembles the traditional mobile phone keypad.
Compact QWERTY	This layout features two letters on each key. The key size is slightly bigger than on the full QWERTY layout.

Entering text

Use the following keys while entering text using the onscreen keyboard:

	Press and hold keys with gray characters at the top to enter numbers, symbols, or accented letters. The gray character displayed on the key is the character that will be inserted when you press and hold that key. Some keys have multiple characters or accents associated with them.
	Shift key. Tap to enter an uppercase letter. Tap twice to turn on caps lock.
	Tap to switch to the numeric and symbol keyboard.
	Enter key. Tap to create a new line.
	Backspace key. Tap to delete the previous character.
	Language key. The key you see depends on the keyboard language you are currently using. Tap to switch to another keyboard language. You can also access onscreen keyboard settings.



Tap to toggle between Multitap and XT9 predictive modes when using the Compact QWERTY or Phone keypad layout.



Tap to hide the onscreen keyboard.

Enabling multiple keyboard languages

If there are multiple keyboard languages available on your phone, you can choose which languages to enable in the onscreen keyboard so that you can switch to these languages and use them to enter text.

1. From the Home screen, press , and then tap **Settings > Language & keyboard > Touch Input**.
2. Tap **International keyboard**.
3. Choose the languages you want.



Available languages depend on the region where you purchased the phone.

Changing to the landscape onscreen keyboard

When entering text, you can choose to use the landscape orientation of the onscreen keyboard. Turn HTC Flyer sideways to use a larger keyboard for easy typing.



- Select the **Auto-rotate screen** check box in **Home > Menu > Settings > Display** to allow the screen orientation to automatically change.
- The landscape orientation keyboard is not supported in all apps.

Entering words with predictive text

The onscreen keyboard has predictive text to help you type quickly and accurately. Predictive text input is enabled by default, and word suggestions are displayed as you type.

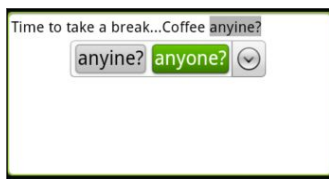

To enter a word in predictive mode, do any of the following:

- If you see the word you want highlighted in green or orange, just tap the space bar to insert the word into your text.
- If you see the word you want shown in the suggestions before you have finished typing the entire word, tap the word to insert it into your text.
- If an arrow is shown to the right of the suggestion list, tap the arrow to see more suggestions.

Setting a second language for the keyboard

Aside from the keyboard language you are currently using, you can set the predictive text to be bilingual. As you type, you'll get word suggestions in two languages that you've selected.

1. From the Home screen, press , and then tap **Settings > Language & keyboard > Touch Input**.
2. Tap **Bilingual prediction**, and then choose the language you want.

Adding a word to the predictive text dictionary



HTC Flyer comes with a list of words that it references for predictive text suggestions. While entering text, if you tap any word on the suggestion list, it is automatically added to the predictive text dictionary if it was not in the dictionary already.

You can also add a word to the list manually.

1. From the Home screen, press , and then tap **Settings > Language & keyboard > Touch Input**.
2. Tap **Personal dictionary > Edit personal dictionary > Add new**.
3. Enter the word to add, and then tap **OK**.

Editing or deleting a word in the predictive text dictionary

You can edit or remove words that you previously added to the predictive text dictionary.

1. From the Home screen, press , and then tap **Settings > Language & keyboard > Touch Input**.
2. Tap **Personal dictionary > Edit personal dictionary**
 - To edit a word, tap the word itself.
 - To delete words from the dictionary, press  and tap **Delete**. Then choose the words to remove and tap **Delete**.

Backing up your personal dictionary to your storage card

If you have a storage card installed, you can back up the new words you've added to the predictive text dictionary.

1. From the Home screen, press , and then tap **Settings > Language & keyboard > Touch Input**.
2. Tap **Personal dictionary > Sync personal dictionary > Copy to storage card**
3. When prompted, tap **OK**.

Importing your personal dictionary from your storage card

1. From the Home screen, press , and then tap Settings > Language & keyboard > Touch Input.
2. Tap Personal dictionary > Sync personal dictionary > Restore from storage card
3. When prompted, tap OK.

Entering text by speaking

No time to type? Try speaking the words to enter them in most text fields that let you use the onscreen keyboard.



- First make sure to select the language you'll be using in the **Voice input & output** settings.
- Since HTC Flyer uses Google's speech-recognition service, you need to be connected to the Internet to enter text by speaking.

1. Press and hold the language key. HTC Flyer cues you to speak.
2. Tell HTC Flyer what you want to be typed in.

Setting the voice input language

1. From the Home screen, press , then tap Settings > Voice input & output > Voice recognizer settings.
2. Tap Language, then choose the language you want.



Available languages depend on the voice input languages supported by Google.

Entering text by tracing

Instead of tapping the keys on the onscreen keyboard, you can "trace" to type words.

To trace, slide your finger on the onscreen keyboard to enter words. For example, if you want to type "the", put your finger on the "t" key, and then trace the word (by sliding your finger) "the" on the onscreen keyboard.

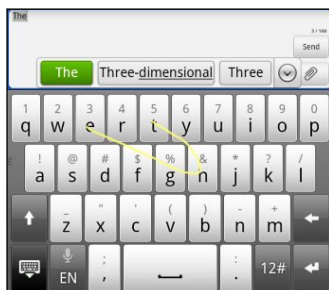

Editing text

It's easy to cut, copy, and paste text using the keyboard.



Some apps may offer their own way of selecting or copying text.

Selecting text

Highlight the text that you want to copy or cut.

1. Press and hold the text field that contains the text to select until the magnifier appears.

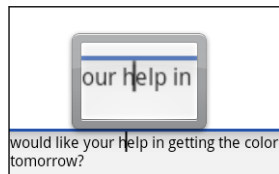

2. Drag your finger to move the text cursor to a letter within the text that you want to select.
3. After positioning the text cursor, lift your finger. The text selection menu then pops up.
4. Do one of the following:
 - Tap **Select word**. When the word where you've placed the text cursor is highlighted, drag the start and end markers to select the text you want.

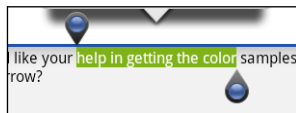



- Tap **Select all** to select everything in the text field.

Copying and pasting text

1. After you have selected the text you want to copy, tap **Copy** or **Cut**. The selected text is then copied to the clipboard.
2. Press and hold a text field in the same or other app until the magnifier appears.
3. Drag your finger to move the text cursor to where you want to paste the text.
4. After positioning the text cursor, lift your finger. The text selection menu then pops up.
5. Tap **Paste**.

Adjusting input settings

Open the Touch Input settings by doing one of the following:

- On the onscreen keyboard, tap the language key (for example, tap  if you're currently using the English onscreen keyboard). Then on the International keyboard options menu, tap **Settings**.
- From the Home screen, press , and then tap **Settings > Language & keyboard > Touch Input**.

International keyboard	Add or remove languages from the onscreen keyboard language list.
Bilingual prediction	Select a secondary keyboard language to use.
Text input	<ul style="list-style-type: none"> ▪ Turn on or off predictive text, spell correction, and word completion. ▪ Enable audible or vibration feedback when typing. ▪ Calibrate the touch keyboard accuracy.
Tutorial	Learn how to use the onscreen keyboard with this interactive tutorial.
Trace keyboard	Set options when tracing to enter text.
Personal dictionary	Add, edit or remove words in the predictive text dictionary.

Internet connections

Data connection

When you turn on HTC Flyer for the first time, it will be automatically set up to use your mobile operator's data connection (if the SIM card is inserted).

Checking the data connection you're using

1. From the Home screen, press , and then tap **Settings > Wireless & networks**.
2. Tap **Mobile networks > Network operators** or **Access Point Names**.



Turning the data connection on or off

Turning your data connection off can help save battery life and save money on data charges. However, if you don't have data connection turned on and you're also not connected to a Wi-Fi network, you won't receive automatic updates to your email, social network accounts, and other synchronized information.

1. From the Home screen, press , and then tap **Settings > Wireless & networks**.
2. Select the **Mobile network** check box to turn on the data connection; clear the check box to turn off the data connection.

Adding a new access point

Before you add another data connection, have the access point name and settings (including username and password if required) from your mobile operator ready.

1. From the Home screen, press , and then tap **Settings > Wireless & networks**.
2. Tap **Mobile networks > Access Point Names**.
3. On the APNs screen, press  and then tap **New APN**.
4. On the Edit access point screen, enter the APN settings. Tap an APN setting item to edit it.
5. Press  and then tap **Save**.

Enabling data roaming

Connect to your mobile operator's partner networks and access data services when you're out of your mobile operator's coverage area.



Using data services while roaming will be costly. Check with your mobile operator for data roaming rates before you use data roaming.

1. From the Home screen, press , and then tap **Settings > Wireless & networks**.
2. Tap **Mobile networks**, and then select the **Data roaming** check box.

Select the **Data roaming sound** check box if you'd like HTC Flyer to play a sound so you'll know when it's connecting to a roaming network.

Wi-Fi

To use Wi-Fi, you need access to a wireless access point or "hotspot". The availability and strength of the Wi-Fi signal will vary depending on objects, such as buildings or simply a wall between rooms, the Wi-Fi signal has to pass through.

Turning Wi-Fi on and connecting to a wireless network

1. From the Home screen, press , and then tap **Settings > Wireless & networks**.
2. Select the **Wi-Fi** check box to turn Wi-Fi on. HTC Flyer then scans for available wireless networks.
3. Tap **Wi-Fi settings**. The network names and security settings of detected Wi-Fi networks are displayed in the Wi-Fi networks section.
4. If the wireless network you want to connect to is not in the list of detected networks, scroll down the screen, and then tap **Add Wi-Fi network**. Enter the wireless network settings, and then tap **Save**.
5. Tap the Wi-Fi network you want to connect to. If you selected an open network, you will be automatically connected to the network.
6. If you selected a network that is secured with WEP, enter the key and then tap **Connect**.

When HTC Flyer is connected to the wireless network, the Wi-Fi icon  appears in the status bar and tells you the approximate signal strength (number of bands that light up).

The next time HTC Flyer connects to a previously accessed secured wireless network, you won't be asked to enter the key or other security information again, unless you reset HTC Flyer to its factory default settings.

Connecting to a Wi-Fi network with EAP-TLS security

You may need to install a network certificate (*.p12) to HTC Flyer before you can connect to a Wi-Fi network with EAP-TLS authentication protocol.

1. Save the certificate file to the root folder of the storage card.
2. From the Home screen, press , and then tap **Settings > Security**.
3. Tap **Install from SD card**.
4. Select the network certificate needed to connect to the EAP-TLS network.
5. Turn on Wi-Fi and connect to a wireless network.

Checking the wireless network status



1. From the Home screen, press , and then tap **Settings > Wireless & networks**.
2. On the Wireless & networks screen, tap **Wi-Fi settings**, and then tap the wireless network that HTC Flyer is currently connected to.

A message box is then displayed showing the Wi-Fi network name, status, speed, signal strength, and more.



If you want to remove the settings for this network, tap **Forget**. If you want to reconnect to a wireless network that you have removed, you'll need to choose the wireless network from the list of available Wi-Fi networks again. If it is a secured wireless network, you'll need to enter the wireless network credentials again.

Connecting to another Wi-Fi network

1. From the Home screen, press , and then tap **Settings > Wireless & networks**.
2. Tap **Wi-Fi settings**. Detected Wi-Fi networks are displayed in the Wi-Fi networks section.
3. To manually scan for available Wi-Fi networks, on the Wi-Fi screen, press , and then tap **Scan**.
4. Tap another Wi-Fi network to connect to it.

About connection widgets

Add the Mobile Network and Wi-Fi widgets or the Data dashboard widget to the Home screen to make it faster for you to turn on or off these connections. Tap the widget or icon on the dashboard to turn on or off the connection.



Connecting to a virtual private network (VPN)

Add, set up, and manage virtual private networks (VPNs) so you can connect and access resources inside a secured local network, such as your corporate network.

Depending on the type of VPN you're using at work, you may be asked to enter your login credentials and install security certificates before you can connect to your company's local network. You can get this information from your network administrator.

Also, HTC Flyer must first establish a Wi-Fi or data connection before you can start a VPN connection.



Setting up secure credential storage

If your network administrator tells you to download and install security certificates, you must first set up secure credential storage on HTC Flyer.

1. From the Home screen, press , and then tap **Settings > Security**.
2. Tap **Set password**.
3. Enter a new password for the credential storage.
4. Scroll down and confirm the password, and then tap **OK**.
5. Select the **Use secure credentials** check box.



You can then download and install the certificates needed to access your local network. Your network administrator can tell you how to do this.

Adding a VPN connection

1. From the Home screen, press , and then tap **Settings > Wireless & networks**.
2. Tap **VPN settings > Add VPN**, and then tap the type of VPN you want to add.
3. Tap the VPN settings and set them up according to the security details your network administrator gave you.
4. Press , and then tap **Save**.

The VPN is then added to the VPNs section of the VPN settings screen.

Connecting to a VPN

1. From the Home screen, press , and then tap **Settings > Wireless & networks**.
2. Tap **VPN settings**.
3. In the VPNs section, tap the VPN that you want to connect to.
4. When asked, enter your log in credentials, and then tap **Connect**. When you're connected, the VPN connected icon  appears in the notification area of the title bar.

You can then open the web browser to access resources such as your corporate network intranet.

Disconnecting from a VPN

1. Press and hold the title bar, and then slide down your finger to open the Notifications panel.
2. Tap the VPN connection to return to the VPN settings screen, and then tap the VPN connection to disconnect from it.

When HTC Flyer has disconnected from the VPN, the VPN disconnected icon  is displayed in the notification area of the title bar.

Using HTC Flyer as a modem (USB tethering)

No Internet connection available for your computer? No problem. Use the data connection on HTC Flyer to connect to the Internet.



- You need your SIM card inserted on HTC Flyer to use the data connection.
- To use HTC Flyer as a modem, you need to install HTC Sync on your computer first.

1. Make sure the data connection on HTC Flyer is turned on.
2. Connect HTC Flyer to the computer using the provided USB cable.
3. On the Connect to PC screen, select **USB tethering**, and then tap **Done**.

Connecting HTC Flyer to the Internet through a computer (Internet Pass-through)

If you don't have a data plan for HTC Flyer or you don't have access to a Wi-Fi network, you can still go online on HTC Flyer by using your computer's Internet connection.



Before you can use your computer as a modem, be sure to install HTC Sync on your computer first.

1. Make sure your computer is connected to the Internet.



Two things to check for your computer's Internet connection. One, you may need to turn off your local network's firewall. Two, if your computer connects to the Internet via PPP (e.g. Dial UP, xDSL, or VPN), Internet Pass-through will only support TCP protocol.

2. Connect HTC Flyer to the computer using the provided USB cable.
3. On the Connect to PC screen, select **Internet pass-through**, and then tap **Done**.

Using HTC Flyer as a wireless router

Share your data connection with other devices by turning HTC Flyer into a wireless router.

Make sure the data connection on HTC Flyer is turned on before you use it as a wireless router.

1. From the Home screen, press , and then tap **Settings > Wireless & networks**.
2. Tap **Portable Wi-Fi hotspot settings**.
3. Enter a router name or use the default router name.
4. Choose the type of Security and set the password (key) for your wireless router. If you selected **None** in Security, you don't need to enter a password.



The password is the key other people need to enter on their device so they can connect and use HTC Flyer as a wireless router.

5. Select the **Portable Wi-Fi hotspot** check box to turn on the wireless router.

HTC Flyer is ready to be used as a wireless router when you see  on the status bar.

Bluetooth

Bluetooth basics

Turning Bluetooth on or off

1. From the Home screen, press , and then tap **Settings** > **Wireless & networks**.
2. Select or clear the **Bluetooth** check box.

An even easier way to turn Bluetooth on or off is with the Bluetooth widget on the Home screen.



Turn off Bluetooth when not in use to save battery power, or in places where using a wireless device is prohibited, such as on board an aircraft and in hospitals.

Changing the device name

The device name identifies HTC Flyer to other devices.

1. From the Home screen, press , and then tap **Settings** > **Wireless & networks**.
2. Tap **Bluetooth settings**.
3. If the **Bluetooth** check box is not selected, select it to turn Bluetooth on.
4. Tap **Device name**.
5. Enter the new name for HTC Flyer in the dialog box, and then tap **OK**.

Connecting a Bluetooth headset or car kit

You can listen to music over a Bluetooth stereo headset, or have hands-free conversations using a compatible Bluetooth headset or car kit. It's the same procedure to set up stereo audio and hands-free.



- For you to listen to music with your headset or car kit, the headset or car kit must support the A2DP Bluetooth profile.
- Before you connect your headset, you need to make it discoverable so HTC Flyer can find it. You can find out how to do this by referring to your headset manual.

1. From the Home screen, press , and then tap **Settings** > **Wireless & networks**.
2. Tap **Bluetooth settings**.
3. If the **Bluetooth** check box is not selected, select it to turn Bluetooth on.
4. Make sure that the headset is discoverable.

5. Tap **Scan for devices**. HTC Flyer will start to scan for Bluetooth devices within range.
6. When you see the name of your headset displayed in the Bluetooth devices section, tap the name. HTC Flyer then automatically tries to pair with the headset.
7. If automatic pairing fails, enter the passcode supplied with your headset.

The pairing and connection status is displayed below the hands-free headset or car kit name in the Bluetooth devices section. When the Bluetooth headset or car kit is connected to HTC Flyer, the Bluetooth connected icon  is displayed in the status bar. Depending on the type of headset or car kit you have connected, you can then start using the headset or car kit to listen to music and/or make and receive phone calls.

Reconnecting a headset or car kit

Normally, you can easily reconnect your headset by switching on Bluetooth on HTC Flyer, and then turning on the headset. However, you might have to connect manually if your headset has been used with another Bluetooth device.

1. From the Home screen, press , and then tap **Settings > Wireless & networks**.
2. Tap **Bluetooth settings**.
3. If the **Bluetooth** check box is not selected, select it to turn Bluetooth on.
4. Make sure that the headset is discoverable.
5. Tap the headset's name in the Bluetooth devices section.
6. If prompted to enter a passcode, try 0000 or 1234, or consult the headset/car kit documentation to find the passcode.

If you still cannot reconnect to the headset or car kit, follow the instructions in [Unpairing from a Bluetooth device](#) on page 185, and then follow the steps under [Connecting a Bluetooth headset or car kit](#) on page 183.

Disconnecting or unpairing from a Bluetooth device

Disconnecting a Bluetooth device

1. From the Home screen, press , and then tap **Settings > Wireless & networks**.
2. Tap **Bluetooth settings**.
3. In the Bluetooth devices section, press and hold the device to disconnect.
4. Tap **Disconnect**.

Unpairing from a Bluetooth device

You can make HTC Flyer forget its pairing connection with another Bluetooth device. Doing so may require you to enter or confirm a passcode again if you want to reconnect to the other device.

1. From the Home screen, press , and then tap **Settings > Wireless & networks**.
2. Tap **Bluetooth settings**.
3. In the Bluetooth devices section, press and hold the device to unpair.
4. Tap **Disconnect & unpair**, or tap **Unpair** if the Bluetooth device is currently not connected to HTC Flyer.

Sending information using Bluetooth

You can use Bluetooth to send information from HTC Flyer to another Bluetooth enabled device such as a phone or notebook computer. You can send the following types of information, depending on the device you are sending to:



- Images and videos
- Calendar events
- Contacts
- Audio files





Before you begin, set the receiving device to discoverable mode. You may also need to set it to “Receive Beams” or “Receive Files”. Refer to the device’s documentation for instructions on receiving information over Bluetooth.

1. On HTC Flyer, open the app that contains the information or file you want to send.
2. Follow the steps for the type of item you want to send:

Captured photo or video	After capturing, on the Camera preview screen, tap  , and then tap Bluetooth .
-------------------------	--

Photos or videos	<ol style="list-style-type: none"> 1. On the Albums tab  of the Gallery app, choose an album. 2. Tap , and then tap Bluetooth. 3. Choose the photos and videos you want to share, and then tap Next.
------------------	---

Contact	<ol style="list-style-type: none"> 1. On the All tab  of the People app, press and hold a contact, and then tap Send contact as vCard. 2. Tap the down arrow icon, and then select Bluetooth from the displayed list. 3. Tap Send.
Calendar appointment or event	In Day view, Agenda view, or Week view, press and hold the event, and then tap Share vCalendar > Bluetooth .
Music track	With the track displayed on the Music app's Now playing screen, press  , and then tap Share > Bluetooth .
Voice recording	On the main Voice Recorder screen, tap  , and then tap Bluetooth .

3. Turn on Bluetooth if you're asked to do so.
4. If you haven't paired with the receiving device before, tap **Scan for devices**.
5. Tap the name of the receiving device.
6. If prompted, accept the pairing request on HTC Flyer and on the receiving device. Also enter the same passcode or confirm the auto-generated passcode on both devices.
7. On the receiving device, accept the file.

Where sent information is saved

When you send information using Bluetooth, the location where it's saved depends on the type of information and the receiving device.

If you send a calendar event or contact, it is normally added directly to the corresponding application on the receiving device. For example, if you send a calendar event to a compatible phone, the event is shown in that phone's calendar application.

If you send another file type to a Windows computer, it is normally saved in the Bluetooth Exchange folder within your personal document folders.

- On Windows XP, the path may be: `C:\Documents and Settings\[your username]\My Documents\Bluetooth Exchange`
- On Windows Vista, the path may be: `C:\Users\[your username]\Documents`
- On Windows 7, the path may be: `C:\Users\[your username]\My Documents\Bluetooth Exchange Folder`

If you send a file to another device, the saved location may depend on the file type. For example, if you send an image file to another mobile phone, it may be saved in a folder named "Images".

Receiving information using Bluetooth

HTC Flyer lets you receive various files with Bluetooth, including photos, music tracks, and documents such as PDFs.

To receive files using Bluetooth, make sure that your storage card is inserted.

1. From the Home screen, press , and then tap **Settings > Wireless & networks**.
2. Tap **Bluetooth settings**.
3. If the **Bluetooth** check box is not selected, select it to turn Bluetooth on.
4. Select the **Discoverable** check box.
5. On the sending device, send one or more files to HTC Flyer. Refer to the device's documentation for instructions on sending information over Bluetooth.
6. If asked, accept the pairing request on HTC Flyer and on the receiving device. Also enter the same passcode or confirm the auto-generated passcode on both devices.

You'll then get a Bluetooth authorization request.

7. If you want to automatically receive files from the sending device in future, select the **Always** check box.
8. Tap **Accept** or **OK**.
9. When HTC Flyer receives a file transfer request notification, slide down the Notifications panel, tap the incoming file notification, and then tap **Accept**.
10. When a file is transferred, a notification is displayed. To open the file immediately, slide down the Notifications panel, and then tap the relevant notification.

When you open a received file, what happens next depends on the file type:

- Media files and documents are usually opened directly in a compatible app. For example, if you open a music track, it starts playing in the Music app.
- For a vCalendar file, choose the calendar where you want to save the event, and then tap **Import**. The vCalendar is added to your Calendar events.
- For a vCard contact file, if there are multiple vCard files on your storage card, you can choose to import one, several, or all of those contacts to your contacts list.

Adding the Bluetooth received folder to the Home screen

You can add a folder to the Home screen that shows all files you have received with Bluetooth.

1. From the Home screen, tap .
2. On the Personalize screen, tap Folder > Bluetooth received.
3. Press and hold the Bluetooth received folder icon, and drag it to the Home screen position you want.

To view the folder contents, tap the folder icon. To open a file, tap the file name.

Security

Protecting your SIM card with a PIN

Add another layer of security for HTC Flyer by assigning a PIN (personal identification number) to your SIM.

Make sure you have the default SIM PIN provided by your mobile operator before continuing.

1. From the Home screen, press , and then tap **Settings > Security**.
2. Tap **Set up SIM card lock**, then select **Lock SIM card**.
3. Enter the default SIM card PIN, and then tap **OK**.
4. To change the SIM card PIN, tap **Change SIM PIN**.

Restoring a SIM card that has been locked out

If you enter the wrong PIN more times than the maximum number of attempts allowed, your SIM card will become “PUK-locked.”

You need a PUK code to restore access to HTC Flyer. This code may have been provided by your mobile operator when you received your SIM card.

1. On the Phone dialer screen, enter the PUK code, and then tap **Next**.
2. Enter the new PIN you want to use, and then tap **Next**.
3. Enter the new PIN again, and then tap **OK**.

Protecting HTC Flyer with a screen lock pattern, PIN, or password

Protect your personal information and prevent others from using HTC Flyer without your permission by setting a screen lock pattern, PIN or password.

Your screen lock will be asked every time HTC Flyer is turned on or when it's idle for a certain period of time.

1. From the Home screen, press , and then tap **Settings > Security**.
2. Tap **Set up screen lock**.

3. Tap one of the following:

None	Disable the screen lock you've previously created.
Pattern	Set a screen lock pattern by following the onscreen instructions.
PIN	Set a numeric password of at least four digits.
Password	Set an alpha-numeric password.

4. On the Security screen, tap **Lock phone after**, then specify the idle time you can allow before the screen is locked.



You can also clear the **Use visible pattern** or **Visible passwords** on the Security screen if you don't want your screen lock to display as you enter it onscreen.

Changing your screen lock

1. From the Home screen, press , and then tap **Settings > Security**.
2. Tap **Change screen lock**.
3. Enter your current screen lock to confirm that you want to change it.
4. Choose a different screen lock type, then enter your new pattern, PIN, or password. Or tap **None** if you don't want to use a screen lock.

Forgot your screen lock pattern?

If you've forgotten your screen lock pattern, you have up to five attempts to try and unlock HTC Flyer.

If this fails, you can unlock HTC Flyer by entering your Google Account user name and password.

1. On the unlock screen, enter your lock pattern.
2. After the fifth attempt, when you're asked to wait for 30 seconds, tap **OK**.
3. If the display goes off, press the **POWER** button to turn the display back on, and then unlock the screen.
4. Tap the **Forgot pattern?** button when it appears.
5. Enter your Google Account name and password, and then tap **Sign in**. You'll then be asked to create a new screen lock pattern. If you no longer want to do so, tap **Cancel**.

Settings

Settings on HTC Flyer

Control and customize tablet settings on the Settings screen.

From the Home screen, press , and then tap **Settings**.

Personalize	Make HTC Flyer truly yours with the various personalization options available.
Wireless & networks	Set up wireless connections, such as Wi-Fi, data connection, and Bluetooth, enable Airplane mode, and more.
Sound	<ul style="list-style-type: none"> ▪ Choose sounds to use for notifications. ▪ Adjust media playback volume.
Display	Set up display settings such as automatic screen orientation, brightness, screen timeout, and more.
Accounts & sync	Log in or out of your social network accounts, Google Account, Exchange ActiveSync account, and HTC Sense.com account. You can also manage synchronization and other settings for your accounts.
Location	Select the sources to use when determining your location. Select Phone finder so you can use HTC Sense.com to locate HTC Flyer.
Search	Select items to include when you do a search and set Google search options.
Pen	Set options for the pen when you use it to interact with HTC Flyer.
Privacy	Choose to automatically back up some settings (e.g. Wi-Fi passwords or Bookmarks) to Google servers using your Google Account so you can restore them when needed.
Connect to PC	<ul style="list-style-type: none"> ▪ Set the default USB connection type to use whenever you connect HTC Flyer to your computer. ▪ Or, select the Ask me check box to set HTC Flyer to always display the screen for selecting the USB connection type.
Security	Set a screen lock, enable the SIM card lock, or manage the credential storage.
Dock	If you purchased the dock, choose the behavior when you mount HTC Flyer to the dock.
Power	Turn on power saver to automatically switch to power saving mode when the battery level goes down to the level that you set.

Applications	Manage running applications, install or uninstall programs, set low memory notification, and more.
SD & phone storage	<ul style="list-style-type: none"> ▪ Check the available space in the internal storage and your storage card. ▪ From this screen, be sure to unmount your storage card before you remove it from HTC Flyer. ▪ You can also do a factory reset.
Date & time	Set the date and time, time zone, and date or time format.
Language & keyboard	Set the operating system language and region. You can also set onscreen keyboard options.
Accessibility	Use these settings when you've downloaded and installed an accessibility tool, such as a screen reader that provides voice feedback. You can turn accessibility functions or services on or off.
Voice input & output	Set up the voice input options. Also, if you've installed a text-to-speech (voice data) application, use this to set the text-to-speech settings.
About tablet	<ul style="list-style-type: none"> ▪ Turn on or off scheduled checks for system software updates, or manually check for updates. ▪ Turn Tell HTC on or off. When enabled, you're helping us know if HTC Flyer encounters a technical problem. ▪ View different information about HTC Flyer, such as the battery level, hardware and software information, and more.

Changing display settings

Adjusting the screen brightness manually

1. From the Home screen, press , and then tap **Settings**.
2. Tap **Display > Brightness**
3. Clear the **Automatic brightness** check box.
4. Drag the brightness slider to the left to decrease or to the right to increase the screen brightness.
5. Tap **OK**.

Adjusting the time before the screen turns off

After a period of inactivity, the screen turns off to conserve battery power. You can set the idle time before the screen turns off.

1. From the Home screen, press , and then tap **Settings**.
2. Tap **Display > Screen timeout**.
3. Tap the time before the screen turns off.

Turning automatic screen rotation off

By default, the screen orientation automatically adjusts depending on how you hold HTC Flyer.



Automatic rotation is not supported in all application screens.

1. From the Home screen, press , and then tap **Settings**.
2. Tap **Display**.
3. Clear the **Auto-rotate screen** check box.

Recalibrating the G-sensor

Recalibrate the screen if you feel that the screen orientation does not respond properly to the way you hold HTC Flyer.

1. From the Home screen, press , and then tap **Settings**.
2. Tap **Display > G-Sensor calibration**.
3. Place HTC Flyer on a flat and level surface, and then tap **Calibrate**.
4. After the recalibration process, tap **OK**.

Keeping the screen on while charging HTC Flyer

You can keep the screen from turning off while you're charging HTC Flyer.

1. From the Home screen, press , and then tap **Settings**.
2. Tap **Applications > Development**.
3. Select the **Stay awake** check box.

Switching animation effects on or off

You can turn off the animation or enable only some animations when switching between screens.

1. From the Home screen, press , and then tap **Settings**.
2. Tap **Display > Animation**.
3. On the options menu, select the animation setting you want.

Changing sound settings

Enabling or disabling audible selection



You can choose to play a sound when you're selecting items onscreen.

1. From the Home screen, press , and then tap **Settings**.
2. Tap **Sound**.
3. Select the **Audible selection** check box.

Changing the language

When you turn HTC Flyer on for the first time, you're asked to choose the language you want to use. If you want, you can still change the language after you set up HTC Flyer. Changing the language adjusts the keyboard layout, date and time formatting, and more.

The languages available to choose from may depend on the version of HTC Flyer you have.

1. From the Home screen, press , and then tap **Settings**.
2. Tap **Language & keyboard > Select language**.
3. Tap the language and corresponding region you want to use.
4. Press  to return to the Home screen. The new language will be applied after a few seconds.

Optimizing battery life

You can set HTC Flyer to automatically switch to power saving mode when the battery level reaches a certain level.

1. From the Home screen, press , and then tap **Settings**.
2. Tap **Power**.
3. Select the **Enable power saver** check box.
4. Tap **Turn power saver on at**, and then select when to switch to power saver mode.
5. Tap **Power saver settings**, and then set and select the behavior when HTC Flyer switches to power saving mode.

Checking the power usage of applications

1. From the Home screen, press , and then tap **Settings**.
2. Tap **About tablet > Battery > Battery use**.

Managing memory

Checking how much internal storage is available for use

1. From the Home screen, press , and then tap **Settings**.
2. Tap **SD & phone storage**. The available storage for use is displayed in the Internal storage section.

Checking the available storage card space

1. From the Home screen, press , and then tap **Settings**.
2. Tap **SD & phone storage**. The total and available storage card space is displayed in the SD card section.

Clearing application cache and data

1. From the Home screen, press , and then tap **Settings**.
2. Tap **Applications > Manage applications**.
3. On the All tab, tap an application.
4. On the screen, tap **Clear data** and/or **Clear cache**.

Uninstalling third-party applications

You cannot uninstall applications that are preinstalled on HTC Flyer.

1. From the Home screen, press , and then tap **Settings**.
2. Tap **Applications > Manage applications**.
3. On the Downloaded tab, tap the application you want to uninstall.
4. Tap **Uninstall**.

Moving applications to or from the storage card

Move downloaded applications to the storage card if the internal storage on HTC Flyer is getting low. Or, if your storage card is getting full, you can also move applications from the storage card to the internal storage.





You can only move applications that are not preinstalled on HTC Flyer.

1. From the Home screen, press , and then tap **Settings**.
2. Tap **Applications > Manage applications**.
3. On the Downloaded tab, tap the application you want to move.
4. Tap **Move to SD card** or **Move to phone**.

Stopping running applications using Task Manager

Use Task Manager to free up memory by stopping running applications that you're not currently using.

1. From the Home screen, tap  > **Task Manager**.
2. In the All applications list, tap  to the right of the application name to stop it.

Checking information about HTC Flyer

1. From the Home screen, press , and then tap **Settings**.
2. Tap **About tablet**.
3. Select one of the following:

Software updates	Enable or disable the automatic check feature for software updates for HTC Flyer. You can also tap Check now to manually check for software updates.
Tell HTC	Turn Tell HTC on or off. When enabled, you're helping us know if HTC Flyer encounters a technical problem. You can also choose when you want to send error reports.
Network	Check information about your mobile operator and its service status.
Phone identity	Check information about HTC Flyer and the SIM card you're using.
Battery	Check information about the battery such as its current battery level, status, and what programs are using the battery.
Hardware information	Check the Wi-Fi MAC and Bluetooth addresses.
Software information	Check the version and other information about the Android platform being used by HTC Flyer. You can also check the version of the web browser.
Legal information	Read legal information from HTC and Google, and licenses used by HTC Flyer.

Update and reset

Software updates

From time to time, software updates for HTC Flyer may be available. HTC Flyer can check and then notify you if there's a new update. You can then download and install the software update using the Wi-Fi or data connection. You can also manually check if there's an available software update.

Depending on the type of update, the update may erase all your personal data and customized settings, and also remove any applications you've installed. Make sure that you've backed up the information and files you want to keep.



Checking and downloading software updates may incur additional data transfer fees from your mobile operator.

Installing an update

Make sure HTC Flyer has a storage card inserted. The update will be downloaded to the storage card.

1. Do any of the following after HTC Flyer receives a software update:
 - If the display is on and you're not using any application, the **Install system software update** dialog box appears on screen. Select **Install now**, and then tap **OK**.
 - If you're in a call, the update notification icon appears in the status bar. After the call, slide open the Notifications panel, and then tap the update notification.
2. Wait for the update to download and install on HTC Flyer. When the update is finished, HTC Flyer will automatically restart.

Checking for updates manually

1. From the Home screen, press , and then tap **Settings**.
2. Tap **About tablet** > **Software updates** > **Check now**.

Restarting HTC Flyer

If HTC Flyer is running slower than normal, an application is not performing properly, or HTC Flyer becomes unresponsive, try restarting HTC Flyer and see if that helps solve the problem.

1. If the display is off, press the POWER button to turn it back on.
2. Unlock the display.
3. Press and hold the POWER button, and then tap **Restart**.
4. When asked to confirm, tap **Restart**.

HTC Flyer not responding?

If HTC Flyer does not respond when you touch the screen or press the buttons, you can still restart HTC Flyer by using its buttons.

1. Press and hold the VOLUME UP and VOLUME DOWN buttons.
2. While still pressing the VOLUME UP and VOLUME DOWN buttons, press and hold the POWER button. HTC Flyer will restart after a few seconds.

Resetting HTC Flyer

Do a factory reset to return HTC Flyer to its original state before the first time you turned it on.

If you're passing HTC Flyer on to someone else or HTC Flyer has a persistent problem that cannot be solved, you can perform a factory reset (also called a hard reset). Factory reset is not a step to be taken lightly. It'll permanently delete all your data and customized settings, and will remove any applications you've downloaded and installed. Be sure to back up any data and files you want to keep before you do a factory reset.

Performing a factory reset via settings

The most convenient way to do a factory reset is via the settings.

1. From the Home screen, press , and then tap **Settings**.
2. Tap **SD & phone storage > Factory data reset**.
3. Tap **Reset phone**, and then tap **Erase everything**.

Performing a factory reset using the tablet buttons

If you can't turn on HTC Flyer or access the tablet settings, you can still perform a factory reset by using the buttons on HTC Flyer.



The **Fast boot** option in **Settings > Power** must not be selected.

1. Press and hold the VOLUME DOWN button, and then briefly press the POWER button.
2. Wait for the screen with the three Android images to appear, and then release the VOLUME DOWN button.
3. Press VOLUME DOWN to select **FACTORY RESET**, and then press the POWER button.

Trademarks and copyrights

©2011 HTC Corporation. All Rights Reserved.

HTC, the HTC logo, the HTC quietly brilliant logo, HTC Flyer, Footprints, HTC Sense, and HTC Sync are trademarks or service marks of HTC Corporation.

©2011 Google Inc. Used with permission. Google, the Google logo, Android, the Android logo, Android Market, the Android Market logo, Google Apps, Google Calendar, Google Checkout, Google Earth, Google Latitude, Google Maps, Google Talk, Gmail, Picasa, and YouTube are trademarks of Google Inc.

Microsoft, Windows, ActiveSync, Outlook, PowerPoint, Windows Media, Windows Vista, and Word are either registered trademarks or trademarks of Microsoft Corporation in the United States and/or other countries.

Bluetooth and the Bluetooth logo are trademarks owned by Bluetooth SIG, Inc.

This device contains Adobe® Flash® Player and Adobe® Reader® Mobile software under license from Adobe Systems Incorporated. Copyright ©1995–2011 Adobe Systems Incorporated. All rights reserved. Adobe and Reader are trademarks of Adobe Systems Incorporated.

Wi-Fi is a registered trademark of the Wireless Fidelity Alliance, Inc.

microSD is a trademark of SD Card Association.

Facebook is a trademark of Facebook, Inc.

Twitter is a trademark of Twitter, Inc., and is used under license.

Flickr is a trademark of Yahoo! Inc.

DLNA is a registered trademark, DLNA disc logo is a service mark, and DLNA Certified is a trademark of the Digital Living Network Alliance.

©2011 Kobo Inc. All rights reserved. Kobo and the Kobo logo are trademarks of Kobo Inc.

iTunes is a trademark of Apple Inc.

All other company, product and service names mentioned herein are trademarks, registered trademarks or service marks of their respective owners.

HTC shall not be liable for technical or editorial errors or omissions contained herein, nor for incidental or consequential damages resulting from furnishing this material. The information is provided “as is” without warranty of any kind and is subject to change without notice. HTC also reserves the right to revise the content of this document at any time without prior notice.

No part of this document may be reproduced or transmitted in any form or by any means, electronic or mechanical, including photocopying, recording or storing in a retrieval system, or translated into any language in any form without prior written permission of HTC.

Index

Symbols

3G *177*

A

Alarm *151*

Android Market *147*

Apps

- deleting *148*
 - installing *147, 169*
-

B

Back up contacts *131*

Battery

- optimizing battery life *194*

Bluetooth

- automatically connecting to a Bluetooth car kit or headset *120*
- connecting a Bluetooth headset or car kit *183*
- disconnecting or unpairing *184*
- sending information *185*
- sharing music *76*
- turning on or off *183*

Browser

- bookmarks *42*
 - navigating and zooming *40*
 - opening a new window *41*
 - options *44*
 - switching between windows *41*
 - using *40*
-

C

Calendar

- creating an event *105*
- inviting guests to your event *106*
- managing events *108*
- reminders *109*
- sending a meeting request *106*
- settings *110*
- views *107*
- widget *110*

Camera

- basics *60*
- effects *63*
- recording a video *62*
- settings *63*
- taking a photo *62*
- using the front camera *61*
- zooming *61*

Car Panel *119*

Change phone language *194*

Clock *149*

Compass *113*

Contacts

- adding *128*
- copying from SIM card *127*
- deleting *132*

Copying text *25*

D

Data connection

- access point *177*
- turning on or off *177*

Delete apps *148*

Delete contacts *132*

Display

- adjusting screen brightness *192*
- changing the time before the screen turns off *193*
- recalibrating G-sensor *193*

DLNA

Downloading

- from Web *42*
- viewing downloads *42*

Drawing over

- photos *48*
 - text *48*
-

E

eBooks *153*

Email *96*

Exchange ActiveSync

- Out of office *103*

- sending a meeting request *103, 106*
- working with Exchange ActiveSync email *103*

F

Facebook *86*
 Factory reset *198*
 Footprints *114*
 Friend Stream *88*

G

Gallery

- editing photos *67*
- sending photos and videos *68*
- sharing photos and videos *69*
- viewing photos in social networks *71*
- watching video *67*

 Gmail *95*
 Google Account *82*
 Google Maps *121*
 Google Talk *92*

H

Hands free *183*
 Hard reset *198*
 Headphones *183*
 Highlighting text *48*
 Home screen

- adding widgets *30*
- rearranging items *33*
- rearranging the home panels *34*

 HTC Clock

- Desk Clock *150*
- setting an alarm *151*
- World Clock *150*

 HTC Sync *162*
 HTCSense.com *79*

I

Internet connection

- data connection *177*
- Internet pass-through *182*
- Tethering *181*
- VPN *180*
- Wi-Fi *178*
- wireless router *182*

 Internet pass-through *182*

K

Keyboard

- copying and pasting text *175*
- editing text *175*
- entering text *171*
- predictive text *172*
- selecting text *175*

 Kid Mode *57*

L

Language *194*
 Locations

- about *111*
- downloading maps *120*
- footprints *114*
- getting directions *116*
- managing services *120*
- purchasing services *120*
- searching for places *111*
- turning on location services *111*
- using Car Panel *119*
- using turn-by-turn navigation *118*
- viewing maps *113*
- widget *121*

M

Mail

- adding a POP3/IMAP account *97*
- adding an Exchange account *97*
- deleting an email account *104*
- managing email messages *100*
- previewing *99*
- sending *101*
- sorting email messages *100*
- unified inbox *98*
- working with Exchange ActiveSync email *103*

Managing memory *195*

Maps *111*

Market *147*

Master reset *198*

Meeting request *103*

Messages

- copying to the SIM card *144*
- deleting *144*
- deleting a conversation *145*

- protecting from deletion *144*
- viewing *140*

MMS *138*

Modem *181, 182*

Multimedia message *138*

Music

- browsing the library *75*
- listening *73*
- playing music from Lock screen *74*
- playlist *75*
- sharing music using Bluetooth *76*
- widget *74*

N

News

- reading stories *156*
- subscribing to channels *156*

Notes

- about *51*
- attaching files *52*
- clipping screens *52*
- creating notebooks *51*
- linking to a calendar event *53*
- reading *53*
- sharing *54*
- syncing notes *51*
- writing *52*

Notifications

- panel *22*

O

Online accounts

- about *82*
- managing *83*

Onscreen keyboard

- copying and pasting text *175*
- editing text *175*
- entering text *171*
- predictive text *172*
- selecting text *175*

Optimizing battery life *194*

P

Pair a Bluetooth device *183*

Pen *45*

People

- adding a new contact *128*

- deleting contacts *132*
- editing a contact *132*
- filtering your contacts *130*
- groups *133*
- merging contact information *129*
- searching for a contact *130*
- widget *135*

Phone settings

- Applications *195*
- Display *192*
- Language & keyboard *194*
- Power *194*
- SD & phone storage *195*
- Sound *194*

Playing music from the Lock screen *74*

PUK (PIN Unblock Key) *189*

Q

Quick Settings *23*

R

Reader

- downloading ebooks *155*

Router *182*

RSS *156*

S

Scenes *28*

Screen

- adjusting screen brightness *192*
- changing the time before the screen turns off *193*
- recalibrating G-sensor *193*

Scribble mode *50*

Search

- Web *39*
- your phone *38*

Security

- changing your screen lock *190*
- locking your phone with a screen lock pattern, PIN, or password *189*

Settings

- Applications *195*
- Language & keyboard *194*
- Power *194*
- SD & phone storage *195*
- Sound *194*

Sharing
 - games and apps *161*

SIM card
 - copying a message *144*

Sketchbook
 - about *54*
 - playing a sketch demo *55*
 - sharing *56*

SMS *137*

Snapbooth *59*

Social networks
 - adding *83*
 - viewing photos *71*

Sound
 - audible selection *194*

Sound set *34*

Stocks *158*

Sync
 - HTC Sync *162*
 - online accounts *84*

T

Tablet pen
 - about *45, 46*
 - changing the battery *45*
 - choosing your pen options *46*
 - highlighting and drawing *48*
 - settings *47*

Photos
 - editing *60, 67*
 - sharing *69*
 - viewing *60*

Tethering *181*

Text message *137*

Timemark *54*

Translate *39*

Turn-by-turn navigation *118*

Twitter for HTC Sense *87*

U

USB *181*

V

Videos
 - recording *62*
 - sharing *69*
 - watching *67*

VPN
 - adding a connection *180*
 - connecting *181*

W

Wallpaper
 - changing *29*

Weather
 - adding cities *152*
 - checking weather *152*

Web browser *40*

Wi-Fi
 - connecting to another network *179*
 - network status *179*
 - turning on *178*

Widgets
 - adding *30*
 - changing settings *31*
 - removing *33*

Wireless router *182*

Y

YouTube
 - sharing videos *71*

Z

Zoodles *57*