



Owner's manual & Installation manual
Benutzerhandbuch und Installationshandbuch
Mode d'emploi et manuel d'installation
Manuale dell'utente e manuale d'installazione
Manual de instrucciones y de instalación

VX401E
VZ401E

**2-DIN DVD MULTIMEDIA STATION WITH 6.2-inch
TOUCH PANEL CONTROL**
**2-DIN-DVD-MULTIMEDIA-STATION MIT 6,2"-
TOUCHPANEL-STEUERUNG**
**STATION MULTIMÉDIA DVD 2-DIN AVEC COMMANDE
ÉCRAN TACTILE DE 6,2 pouces**
**STAZIONE MULTIMEDIALE DVD A 2 DIN CON PANNELLO
DI CONTROLLO A SFIORAMENTO DA 6,2 pollici**
**ESTACIÓN DVD MULTIMEDIA DOBLE DIN CON PANEL
DE CONTROL TÁCTIL DE 6,2 pulgadas**

**DVD MULTIMEDIA STATION WITH 7-inch
TOUCH PANEL CONTROL**
**DVD-MULTIMEDIA-STATION MIT 7"-
TOUCHPANEL-STEUERUNG**
**STATION MULTIMÉDIA DVD AVEC COMMANDE
ÉCRAN TACTILE DE 7 pouces**
**STAZIONE MULTIMEDIALE DVD CON PANNELLO
DI CONTROLLO A SFIORAMENTO DA 7 pollici**
**ESTACIÓN DVD MULTIMEDIA CON PANEL
DE CONTROL TÁCTIL DE 7 pulgadas**

Contents

1. FEATURES	4
Expanding Systems	4
2. PRECAUTIONS	5
3. CONTROLS	7
Operational Panel	7
Functions of Buttons	8
Remote Control	9
Functions of Remote Control Buttons	10
4. CAUTIONS ON HANDLING	12
Operation Panel	12
USB Port	12
Cleaning	12
Handling Discs	13
5. DVD VIDEO SYSTEM	14
DVD Video Features	14
Discs	15
About the registered marks, etc.	16
6. OPERATIONS	17
Basic Operations	17
Radio Operations	20
DVD Video Player Operations	23
7. ACCESSORIES	31
iPod/iPhone Operations	31
USB Operations	33
Bluetooth Audio Player Operations	34
Bluetooth Telephone Operations	36
AUX In / AV In Operations	38
Camera In Operations	38
Setup Operations	39
8. TROUBLESHOOTING	41
9. ERROR DISPLAY	44
10. SPECIFICATIONS	44
INSTALLATION /WIRE CONNECTION GUIDE	46

1. FEATURES

- Double Din 6.2" Touch Panel Control (VX401E)
- Motorized 7" Touch Panel Control (VZ401E)
- OEM Steering Wheel Remote Ready
- DVD Video/CD-DA/MP3/WMA Playback Capability
- Built-In Bluetooth®
- Compatible with iPod® / iPhone® via USB
- DivX Certified® to play DivX® video



Expanding Systems

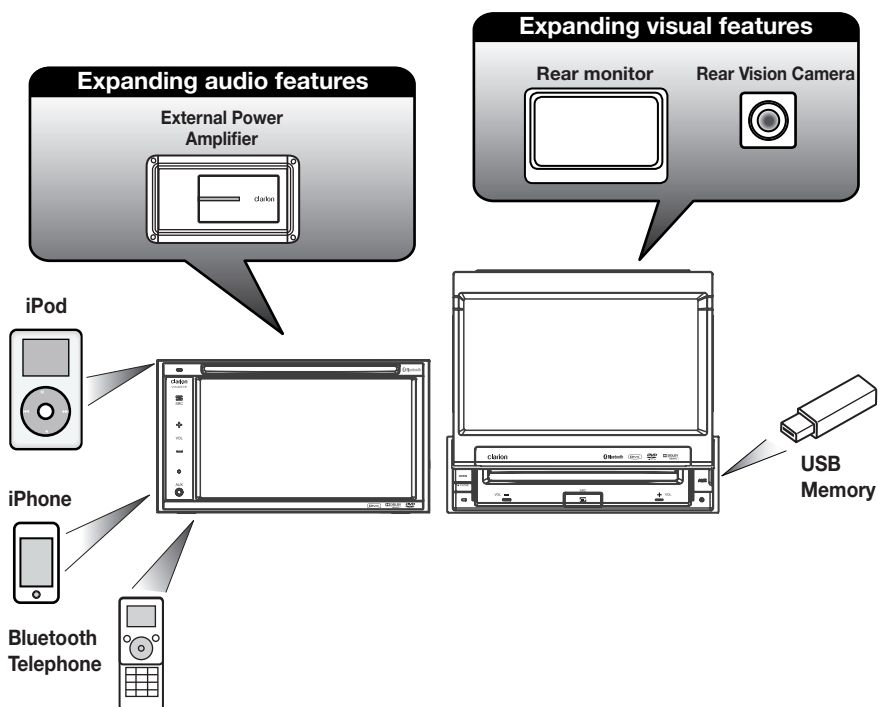

NOTE:

The items listed outside the frames are the commercial products generally sold.

2. PRECAUTIONS

WARNING

- For your safety, the driver should not watch any video sources and/or operate the controls while driving. Please note that watching and operating any video sources while driving are prohibited by law in some countries. Also, while driving, keep the volume to a level at which external sounds can be heard.
- Do not disassemble or modify this unit. It may cause an accident, fire, or electric shock.
- Do not use this unit when a trouble exists, such as no screen content appears or no sound is audible. It may cause an accident, fire, or electric shock. For that case, consult your authorized dealer or a nearest Clarion service center.
- In case of a problem, such as any material has been entered in the unit, the unit gets wet, or smoke or strange smells come out of the unit, etc., stop using this unit immediately, and consult your authorized dealer or a nearest Clarion service center.
Using it in that condition may cause an accident, fire, or electric shock.
- Use a fuse with the same specification only when replacing the fuse.
Using a fuse with a different specification may causes a fire.
- For the installation of this unit or a change in the installation, ask your authorized dealer or a nearest Clarion service center for safety. Professional skills and experiences are required to do so.

1. When the inside of the car is very cold and the player is used soon after switching on the heater, moisture may form on the disc (DVD/ CD) or the optical parts of the player and proper playback may not be possible. If moisture forms on the disc (DVD/CD), wipe it off with a soft cloth. If moisture forms on the optical parts of the player, do not use the player for about one hour. The condensation will disappear naturally allowing normal operation.
2. Driving on extremely bumpy roads which cause severe vibration may cause the sound to skip.
3. This unit uses a precision mechanism. Even in the event that trouble arises, never open the case, disassemble the unit, or lubricate the rotating parts.

CAUTIONS:

This appliance contains a laser system and is classified as a "CLASS 1 LASER PRODUCT". To use this model properly, read this owner's Manual carefully and keep this manual for your future reference. In case of any trouble with this player, please contact your nearest "AUTHORIZED service station". To prevent direct exposure to the laser beam, do not try to open the enclosure.

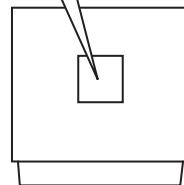
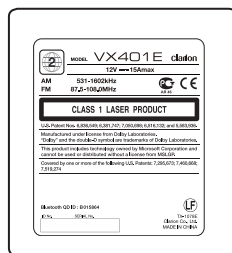

VX401E

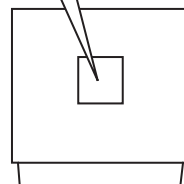
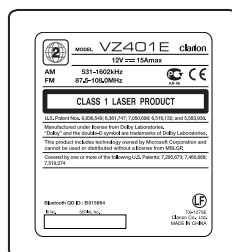

VZ401E

3. CONTROLS

Operational Panel

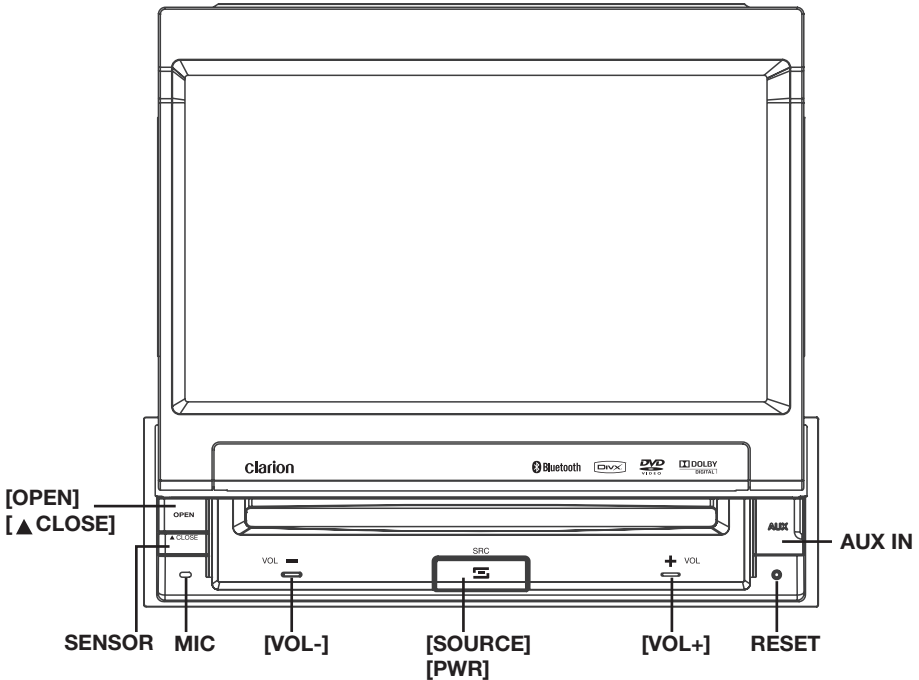
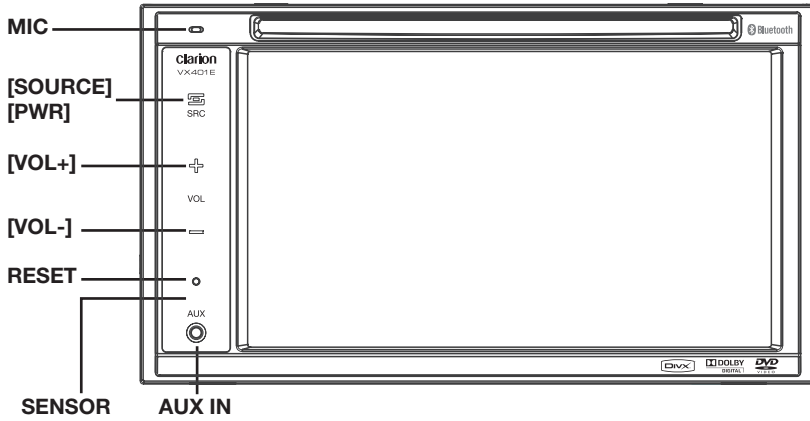

Functions of Buttons

Note: Be sure to read this chapter while referring to front diagram "CONTROLS".

[SRC] Button

- Press this button to turn the unit power on. The Main menu will be displayed. Scroll through the available sources such as AM/FM Tuner, DVD, USB, Camera modes, etc.
- Press and hold this button for more than 2 seconds to turn the power off.

[VOL -], [VOL +] Buttons

- Use these buttons to increase/decrease the volume.

[OPEN] [CLOSE] Button (VZ401E)

- Use this button to open/close operation panel.

RESET Button

- Press this button to reset the unit.

SENSOR

- Receiver for the remote control unit (operating range: 30 degree in all directions).

MIC

- Internal microphone for use during Bluetooth phone calls. Sensitivity can be adjusted from the Settings menu.

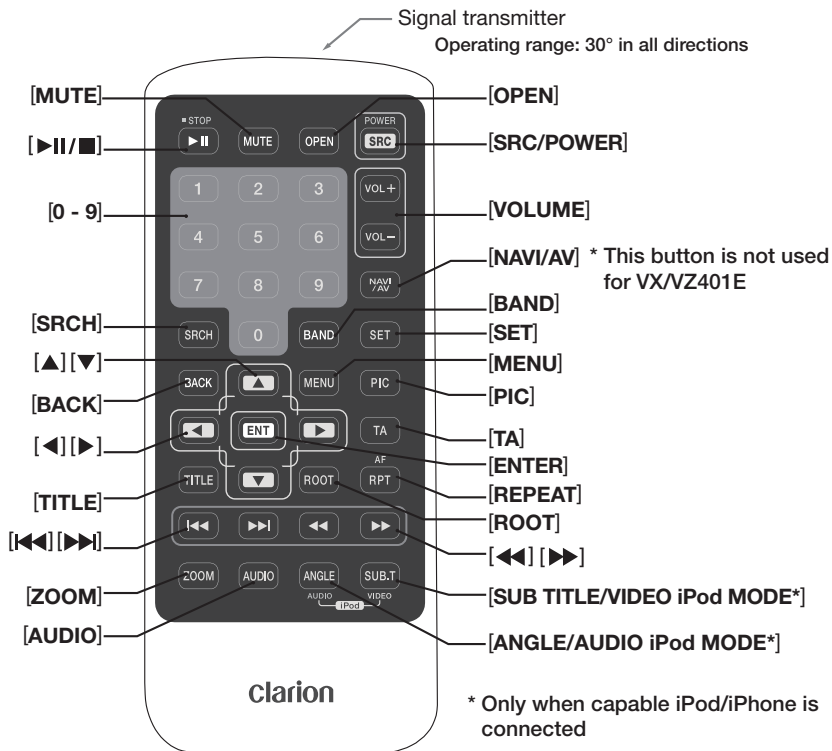

Replacing the batteries

1. Press the retention tab and pull out the battery tray and remove the old battery.
2. Insert the new CR2025 battery and slide the battery tray back in the remote control the same direction that you removed it. Please ensure the tray is inserted in the correct direction.

Note:

Using battery improperly can cause it to explode. Take note of the following points:

- Do not short-circuit, disassemble or heat battery.
- Do not dispose of battery into fire or flames.
- Dispose of discharged battery properly.

⚠ WARNING

Alkaline (CR) button battery contain Perchlorate.
Dispose of discharged battery properly.

Functions of Remote Control Buttons

You can use the remote control unit to control the VX401E and VZ401E.

Note:

- The wireless remote control operation may not be optimal in direct sunlight.

Shared modes

[VOLUME] Button

Increase or decrease volume.

[MUTE] Button

Turns mute on or off.

[OPEN] Button

Press this button to OPEN or CLOSE the motorized screen (VZ401E). Please ensure there are no obstructions before starting the operation.

[SRC/POWER] Button

- Short press to scroll through the available sources such as the tuner, DVD player, iPod, USB modes, etc.
- Long press (over 1 second) to turn off the unit.

[MENU] Button

Press this button to access the MAIN MENU. From the main menu, you can select your desired source or change your settings.

[PIC] Button

Press this button to change monitor Brightness.

[SET] Button

Press this button to access the Audio Settings.

[BACK] Button

Press this button to exit selection and adjustment menus.

[ENTER] button

Press to fix the chosen or entered data.

TUNER Radio mode

[BAND] button

Press this button to switch reception band.

[0 - 9] Buttons

- Use in the Key Pad screen to set the Radio channels.
- Use to select the preset number in the Preset List screen.

[◀◀], [▶▶] Buttons

Press to seek the next available station up or down in the TUNER Radio mode.

[◀◀], [▶▶] Buttons

Press to manually select the next station up or down in the TUNER Radio mode.

[▲], [▼], [◀], [▶] Buttons

- Press [▲], [▼] to scroll through the saved presets list in the TUNER Radio mode.
- Press [◀], [▶] to scroll through the page screens in the TUNER Radio mode.

[TA] Button

Press to set TA standby mode on or off.

DVD PLAYER mode

[▶||■] Button

- Short press to play or pause the video or audio media.
- Long press (over 1 second) to stop the video or audio media.

[SEARCH] Button

Press to open the direct search menu while in the DVD video mode.

[ENTER] Button

Press to select, play or pause video and audio media.

[0 - 9] Buttons

- Press to enter DVD video chapters/titles in the Key Pad screen.
- Press to set the track/folder number of the CD, or MP3/WMA in the Key Pad screen.

[TITLE] Button

Press to go to the title menu on the DVD.

[ROOT] Button

Press to go to the root menu on the DVD.

[▲], [▼], [◀], [▶] Buttons

- Press to select button items on the menu screen of a DVD video.
- Press [◀], [▶] to scroll through the pages screens in the CD and MP3/WMA modes.

Functions of Remote Control Buttons

[|◀◀], [▶▶|] Buttons

- Press to select the next chapter number up or down in DVD video media.
- Press to select the next track up or down in in CD media.

[◀◀], [▶▶] Buttons

Press to perform fastforward and fastbackward. Press again to advance to higher speed reversing or forwarding such as 2x, 4x, 8x and 16x. Press once more to resume normal speed playback.

[REPEAT] Button

- Press to perform chapter repeat in the DVD video mode, and track repeat in CD and MP3/WMA modes.
- Press again to perform title repeat in DVD video mode or folder repeat in MP3/WMA mode. In CD mode, this will activate the repeat all mode.
- Press again to perform all repeat in MP3/WMA playback mode.

[ZOOM] Button

Press to turn on and zoom in while in DVD Video mode. You can zoom in up to 3x.

[AUDIO] Button

Press to switch the AUDIO function in the DVD video mode.

[SUB-T] Button

Press to display subtitles in the DVD video mode.

[ANGLE] Button

Press to switch the ANGLE function in the DVD video mode when the Angle mark is displayed.

MAIN MENU mode

[▶||■], [BAND] Buttons

Press to scroll through the available sources and the Settings.

[▲], [▼], [◀], [▶] Buttons

Press to scroll through the available keys.

[ENTER] Button

Press to select the menu.

4. CAUTIONS ON HANDLING

Operation Panel

For a longer service life, be sure to read the following cautions.

- The operation panel will operate properly in a temperature range of 0° to 60° C.
- Do not allow any liquids on the set from drinks, umbrellas etc. Doing so may damage the internal circuitry.
- Do not disassemble or modify the set in any way. Doing so may result in damage.
- Subjecting the operation panel to shocks may result in breakage, deformation or other damage.
- Do not let cigarettes burn the display.
- If a problem should occur, have the set inspected at your store of purchase.
- Do not insert objects or poke in the space between the operation panel and the main unit when the panel is tilted.
- The remote control unit may not work if the remote control sensor is exposed to direct sunlight.
- In extremely cold weather, the display movement may slow down and the display may darken, but this is not a malfunction. The display will work normally when the temperature increases.
- Small black and shiny spots inside the liquid crystal panel are normal for LCD products.

USB Port

- The USB memory stick may stick out when inserted, so it may cause danger during driving. In such cases, you can use a commercial USB extension cable, etc., but use it safely under your own judgement.
- The USB memory sticks must be recognized as "USB mass storage class" to work properly. Some models may not operate correctly.
When the memorized data is lost or damaged by any chance, Clarion shall not be liable for any damage.
When using an USB memory stick, we recommend that you backup your data stored on it before by using a personal computer etc.
- Data files may be broken when using USB memory sticks in the following situation:
When disconnecting the USB memory stick or turning the power off during writing or reading data.
When affected by static electricity or electric noise.
Connect/disconnect the USB memory stick when it is not accessed.
- Some USB memory sticks cannot be inserted to the main unit because of their shape. In such cases, use a commercial USB extension cable to connect them.
- Connecting with the computer is not covered.
- Music files (MP3, WMA, etc.) stored in the USB memory stick can be played back.

Cleaning

• **Cleaning the cabinet**

Use a soft, dry cloth and gently wipe off the dirt. For tough dirt, apply some neutral detergent diluted in water to a soft cloth, wipe off the dirt gently, then wipe again with a dry cloth.

Do not use benzene, thinner, car cleaner, etc., as these substances may damage the cabinet or cause the paint to peel.

Also, leaving rubber or plastic products in contact with the cabinet for long periods of time may cause stains.

• **Cleaning the liquid crystal panel**

The liquid crystal panel tends to collect dust, so wipe it off occasionally with a soft cloth. The surface is easily scratched, so do not rub it with hard objects.

Handling Discs

Handling

- New discs may have some roughness around the edges. If such discs are used, the player may not work or the sound may skip. Use a ball-point pen or the like to remove any roughness from the edge of the disc.

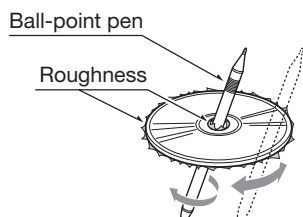

- Never stick labels on the surface of the disc or mark the surface with a pencil or pen.
- Never play a disc with any cellophane tape or other glue on it or with peeling off marks. If you try to play such a disc, you may not be able to get it back out of the DVD player or it may damage the DVD player.
- Do not use discs that have large scratches, are misshapen, cracked, etc. Use of such discs may cause misoperation or damage.
- To remove a disc from its storage case, press down on the center of the case and lift the disc out, holding it carefully by the edges.
- Do not use commercially available disc protection sheets or discs equipped with stabilizers, etc. These may damage the disc or cause breakdown of the internal mechanism.

Storage

- Do not expose discs to direct sunlight or any heat source.
- Do not expose discs to excess humidity or dust.
- Do not expose discs to direct heat from heaters.

Cleaning

- To remove fingermarks and dust, use a soft cloth and wipe in a straight line from the center of the disc to the circumference.
- Do not use any solvents, such as commercially available cleaners, anti-static spray, or thinner to clean discs.
- After using special disc cleaner, let the disc dry off well before playing it.

On Discs

- Exercise a good precaution when loading a disc. The operation panel will close automatically when leaving it open for a while.
- Never turn off the power and remove the unit from the car with a disc loaded.

CAUTION

For your safety, the driver should not insert or eject a disc, opening the operation panel while driving.

5. DVD VIDEO SYSTEM

DVD video is a high-quality digital video source that provides crisp and clear images. One 12 cm disc contains either one film or four hours of music.

DVD Video Features

This unit provides the following functions in addition to the high image quality and sound quality of DVD video.

Note:

- *The functions described in this section, for example, the recorded language, subtitles, angles, etc. differ depending on the DVD video disc. Refer to the instructions provided with the DVD video.*
- *Some disc functions may operate differently from described in this manual.*

Multi-sound function

DVD video can store up to 8 languages for one film; select the language of your preference.

- The languages stored on the disc are indicated by the icon shown below.



Multi-angle function

A DVD video that is filmed from multiple angles allows you to select the angle of choice.

- The number of recorded angles are indicated by the icon shown below.

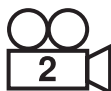

Subpicture (subtitles) function

A DVD video can record subtitles for up to 32 languages and you can select the language of the subtitles you wish to see. The number of recorded subtitle languages are indicated by the icon shown below.



Multi-story function

When a DVD video contains more than one story for a film, you can select the story you wish to enjoy. The operation procedures vary with the disc; observe the instructions for selecting a story provided during playback.

Menu screens

Menu can be called up during DVD video playback to perform menu setting.

- Example showing menu display

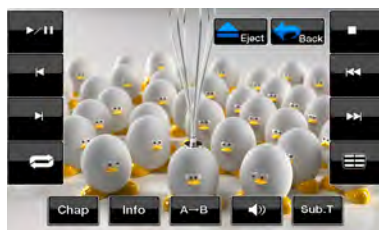

Discs

Playable discs

This DVD video player can play the following discs.

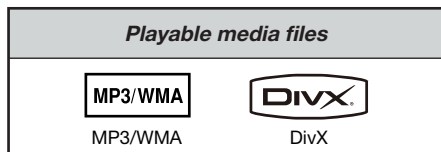
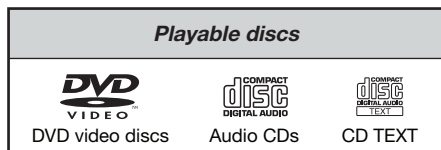

About CD Extra discs

A CD Extra disc is a disc in which a total of two sessions have been recorded. The first session is Audio session and the second session is Data session.

Your personally-created CDs with more than second data sessions recorded cannot be played on this DVD video player.

Note:

- When you play a CD Extra disc, only the first session will be recognized.

About playing a CD-R/CD-RW disc (MP3, WMA)

This player can play CD-R/CD-RW discs previously recorded in music CD format (MP3, WMA).

About playing a DVD-R/RW or DVD+R/RW disc

This player cannot play DVD-R/RW and DVD+R/RW discs previously recorded in video CD format.

However, MP3/WMA files recorded on DVD-R/RW and DVD+R/RW discs can be played.

Discs that cannot be played back

This DVD video player cannot play back DVD-Audio, DVD-RAM, Photo CDs, etc.

Note:

- It may also not be possible to play back CDs recorded on a CD-R unit and CD-RW unit. (Cause: disc characteristics, cracks, dust/dirt, dust/dirt on player's lens, etc.)
- If a CD-R or CD-RW disc that has not been finalized is played, it will take a long time to start playing. Also, it may not be possible to play depending on its recording conditions.
- You cannot play SuperAudio CDs. Playback of the CD player is not supported even if it is a hybrid disc.

About MP3/WMA playback

This unit can play back CD-R/CD-RW, DVD-R/RW and DVD+R/RW discs on which MP3/WMA music data have been recorded.

For a detailed information, see the section entitled "Listening to MP3/WMA".

Note on region numbers

The DVD video system assigns a region number to DVD video players and DVD discs by sales area. DVD video players sold in Europe can play back DVD discs with the region number "ALL", "2" or any combination of numbers that also incorporate a "2".

The DVD video region number is marked on the disc jacket as shown below.



About the registered marks, etc.

- This product incorporates copyright protection technology that is protected by U.S. patents and other intellectual property rights. Use of this copyright protection technology must be authorized by Rovi Corporation, and is intended for home and other limited viewing uses only unless otherwise authorized by Rovi Corporation. Reverse engineering or disassembly is prohibited.
 - Manufactured under license from Dolby Laboratories. "Dolby", "Pro Logic" and the double-D symbol are trademarks of Dolby Laboratories.
 - "Made for iPod," and "Made for iPhone" mean that an electronic accessory has been designed to connect specifically to iPod, or iPhone, respectively, and has been certified by the developer to meet Apple performance standards. Apple is not responsible for the operation of this device or its compliance with safety and regulatory standards.
- iPhone and iPod are trademarks of Apple Inc., registered in the U.S. and other countries. iTunes® is a trademark of Apple Inc.
- The Bluetooth® word mark and logos are owned by the Bluetooth® SIG, Inc. And any use of such marks by Clarion Co.,Ltd. is under license. Other trademarks and trade names are those of their respective owners.
 - DivX®, DivX Certified® and associated logos are registered trademarks of DivX, Inc. and are used under license.
 - All marks, channel names and logos are the property of their respective owners.
 - Covered by one or more of the following U.S. Patents: 7,295,673; 7,460,668; 7,519,274

6. OPERATIONS

Basic Operations

Note:

- Be sure to read this chapter referring to the chapter "3. CONTROLS"

⚠ CAUTION

When the unit is turned on, starting and stopping the engine with its volume raised to the maximum level may harm your hearings. Be careful about adjusting the volume.

Turning ON and OFF the Power

Note:

- Start the engine before using this unit.
- Be careful about using this unit for a long time without running the engine. If you drain the car's battery too far, you may not be able to start the engine and this can reduce the service life of the battery.

1. Start the engine. The power button illumination on the unit will light up.
2. Press the [SRC] button on the unit to turn ON the power. Or press the [SRC/POWER] button on the remote control to turn ON the power.
3. To turn OFF the power, press and hold the [SRC] power button on the unit for more than 2 seconds. Or press the [SRC/POWER] button on the remote control to turn OFF the power for more than 1 seconds.

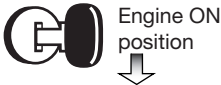

Opening and Closing Operational Panel

Press [OPEN] button on the unit (VZ401E). The operational panel will be open. Press the same button again to close the panel.

⚠ CAUTION

- Do not move the operation panel forcibly or apply strong force to the operation panel.
- When the operation panel is operating, be careful not to get your hand or finger caught between the operation panel and main unit or its mechanical parts.
- The driver should not operate the operation panel while driving.

Adjusting the Angle of the Operational Panel

Touch the settings key to enter into the Monitor Adjust to adjust the desired angle (VZ401E).

Selecting a Mode

1. Touch the desired source key you wish to change to: Tuner, Disc, USB, AUX IN, AV IN, iPod/iPhone, etc.

*External equipment not connected to this unit is not displayed.



Touch the [10:00] to display the time.

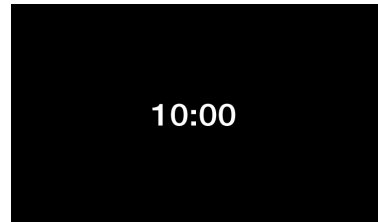

2. Press the [SRC] button to scroll through the available sources.

Basic Operations

Turning Monitor ON or OFF

1. Touch the screen button **Monitor OFF** on the Main Menu to turn Off the screen.
2. Touch the screen again to turn monitor screen On.

[Monitor off]: Turn off the screen.

[Audio off]: Turn off the audio of source.

Adjusting the Volume

Press **[VOL-]/[VOL+]** buttons to adjust the volume.

[VOL -]: Decreases the volume.

[VOL +]: Increases the volume.

- The volume level indicated in the display is in a range from 0 (min.) to 40 (max.).

CAUTION

While driving, keep the volume level at which external sounds can be heard.

Mute

Press the **[MUTE]** button on the remote control to turn mute On and Off.

Adjusting the Settings

1. Press **[Settings]** to enter the setting menu mode.
2. Press the desired mode key. Modes come in the following order:
 - General
 - Audio
 - Regional
 - Monitor Adjust
 - Video
 - Rating
 - Others
 - Rating
 - Others
 - Rating
 - Others



3. Perform the adjustment for the desired item. See the following sections for details.

Adjusting the Audio Settings

1. Touch the **[Audio Settings]** key on the screen or press the **[SET]** key on the remote control.



2. Touch the item key to adjust. Perform the adjustment.



3. Touch the **[▼]/[▲]** keys to scroll between the pages.
4. Touch the **[↶]** key to return to the previous screen.



* In the above sections, only the details regarding adjustments are described, procedures to select items are skipped.

Basic Operations

Adjusting the EQ

The EQ can be adjusted as follows.

1. Touch the [◀] or [▶] key to select your settings.
2. To set your preferable setting, select User.
3. Select from preset setting list:
Flat, Jazz, Pop or Classical.

Adjusting the Bass

The Bass gain and Bass frequency can be adjusted as follows.

1. Touch [-] or [+] key to set the desirable level.
2. To set the Bass center frequency, enter the Audio adjustment in the Settings menu.
3. To set the Bass Q-Factor, enter the Audio Adjustment in the Settings menu.

Adjusting the Treble

The Treble gain and Treble frequency can be adjusted as follows.

1. Touch [-] or [+] key to set the desirable level.
2. To set the Treble center frequency, enter the Audio adjustment in the Settings menu.

Adjusting the Balance/Fader

The Balance or Fader can be adjusted as follows.

1. Touch the [R] or [F] key to adjust to the fader level.
 - The factory default setting is "0".
(Adjustment range: front 9 to rear -9)
2. Touch the [Left] or [Right] key to adjust to the balance level.
 - The factory default setting is "0".
(Adjustment range: left -9 to right 9).

Adjusting the Subwoofer

The Subwoofer can be adjusted as follows.

1. Touch the [-] or [+] key to adjust to the subwoofer level.
 - The factory default setting is "0".
(Adjustment range: left -9 to right 9).

Adjusting the Loudness

The Loudness can be adjusted as follows.

1. Touch the [◀] or [▶] key to turn loudness On or Off.

Adjusting the clock

1. Touch the [Settings] key. The Settings menu will be displayed.
2. Touch the [Clock] key in **General** sub menu.
3. Set up the time by touching the digital numbers on the screen. After inputting the time, you can choose AM or PM if the Clock Mode is set to 12 Hr.



4. Touch the [Clock Mode] to change time settings to 12Hr or 24Hr.

Reset to Factory Defaults

1. Touch the [Settings] key. The Settings menu will be displayed.
2. Touch the [Others] key.
3. Touch the [Reset] key.
Select [YES] to restore your unit to factory default settings. This function will erase all memory from the unit and you must reset all personalized items such as tuner presets.

NOTE:

- You will be asked once to confirm if you want to use the default setting. The unit will close the panel automatically.

Radio Operations

Listening to the Radio

1. Touch the **[Tuner]** key on the Main menu display. The tuner mode screen is displayed.
2. Touch the **[BAND]** key or touch the **[BAND]** button on remote control to select the radio band. Each time the button is pressed, the radio reception band changes in the following order: FM1, FM2, FM3, AM, FM1...



- | | |
|------------------------|--------------------|
| 1 - Band key | 7 - Seek Down key |
| 2 - Scan key | 8 - Seek Up key |
| 3 - Tune Up key | 9 - Eject key |
| 4 - Tune Down key | 10 - Main Menu key |
| 5 - Audio Settings key | 11 - Tuner display |
| 6 - List key | |

Seek Tuning

1. Touch the **[BAND]** key to select the radio band (FM or AM).
2. Touch the **[▲_{Seek}]** or **[▼_{Seek}]** key to automatically seek a station.
 - When touching the **[▲_{Seek}]** key, the station is sought in the direction of higher frequencies.
 - When touching the **[▼_{Seek}]** key, the station is sought in the direction of lower frequencies.

LOC/DX Setting

The DX / LOC setting changes the tuner sensitivity in order to separate closely spaced stations. This feature is useful in areas that have many radio stations in close proximity.

1. Touch the **[List]** key to display the Preset List screen.
2. Touch the **[DX]** key to switch to DX tuner sensitivity.
3. Touch the **[LOC]** key to switch to Local tuner sensitivity.

Manual Tuning

1. Touch the **[BAND]** key to select the radio band (FM or AM).
2. Touch the **[▲_{M-Seek}]** or **[▼_{M-Seek}]** key to manually seek a station.
 - When touching the **[▲_{M-Seek}]** key, the station is tuned in the direction of higher frequencies.
 - When touching the **[▼_{M-Seek}]** key, the station is tuned in the direction of lower frequencies.

Recalling a preset station

There are 2 ways to recall the preset station.

- Using the tuner unit:
 1. Touch the **[BAND]** key to select the desired band (FM or AM) on the tuner.
 2. Touch the **[List]** key to display the Preset List screen.
 3. Touch **[▲]** or **[▼]** to select next station up or down the preset list.
 4. Touch the preset station (1 to 6) on tuner display.
- Using the remote control:
 1. Touch the **[BAND]** button to select the desired band (FM or AM) on the remote control.
 2. Touch the preset number (1 to 6) on numeric pad.

Manual memory

1. Touch the desired Band key to select the band you wish to store in.
2. Tune in the station you wish to store using the seek tuning, manual tuning, or preset tuning.
3. Touch **[▲]** or **[▼]** to select next station up or down the preset list.
4. Touch and hold the desired Preset key you wish to store the current station for more than 2 seconds.

Auto Store

The Auto Store is a function for storing up to 6 stations that are automatically tuned in sequentially. If 6 receivable stations cannot be received, a previously stored station remains overwritten at the memory position.

1. Touch the **[Band]** key to select the desired band. (FM or AM)
2. Touch and hold the **[AS/PS]** key to start the Auto Store function. A beep sounds and the stations with good reception are stored automatically to the preset channels.

Radio Operations

Preset Scan

The Preset Scan receives the stations stored in the preset memory in order. This function is useful when searching for the desired station in memory.

1. Touch the **[Band]** key to select the desired band. (FM or AM).
2. Touch the **[List]** key to display the Preset List screen.
3. Touch the **[AS/PS]** key to start the Preset Scan. The unit starts scanning each station for 10 seconds sequentially. Presets with a weak signal will be skipped.

About the RDS (Radio Data System)

This unit has a built-in RDS decoder system that supports broadcast stations transmitting RDS data. This system can display the name of the broadcast station being received (PS), and can automatically switch to the broadcast station with the best reception as you move long distances (AF switching). Also, if a traffic announcement or program type information is broadcast from an RDS station, no matter what mode you are in, this broadcast is received.

Note:

The RDS interrupt does not function during AM radio reception.

AF (Alternative Frequency) function

The AF function switches to a different frequency on the same network in order to maintain optimum reception.

Switching ON/OFF the AF function

1. Touch the **[List]** key.



2. If the AF function is OFF, touch **[AF]** button to set AF ON. **[AF]** button will be lighted, and "AF" will be displayed at the top of the screen.
3. Touch **[AF]** button again to set AF OFF.

REG (Regional Program) function

When the REG function is ON, the optimum regional station can be received. When this function is OFF, if the regional station area is switched as you drive, a regional station for that region is received.

Note:

- This function is disabled when a national station such as BBC R2 is being received.
- The REG function ON/OFF setting is enabled only when the AF function is ON.

Switching ON/OFF the REG function

1. Touch the **[List]** key.
2. If the REG function is OFF, touch **[REG]** button to set REG ON. **[REG]** button will be lighted, and "REG" will be displayed at the top of the screen.
3. Touch **[REG]** button again to set REG OFF.

TA (Traffic Announcement) function

When a traffic announcement broadcast starts during the TA standby mode, the traffic announcement broadcast is received as top priority regardless of the function mode, so you can listen to it. The Traffic Program (TP) automatic tuning is also available.

Setting TA standby mode

1. Touch the **[List]** key.
2. If the TA standby mode is OFF, touch **[TA]** button to set TA standby mode ON. **[TA]** button will be lighted. "TA" will be displayed at the top of the screen. When an RDS broadcast station with traffic announcement program is received, "TP" will be displayed at the top of the screen.
3. Touch **[TA]** button again to set TA standby mode OFF.

Radio Operations

PTY (Program Type) function

This function enables you to listen to a broadcast of the specified program type when the broadcast starts, even if the system operates in a mode other than the Tuner mode. Some countries do not yet have PTY broadcast. In the TA standby mode, a TP station has priority over a PTY broadcast station.

Selecting PTY

1. Touch the **[List]** key.
2. If the PTY standby mode is OFF, touch **[PTY]** button to set PTY standby mode ON. **[PTY]** button will be lighted, and "PTY" will be displayed at the top of the screen. Touch the button again to set PTY standby mode OFF.
3. Touch **[PTY Select]** button to display the PTY Select screen.



4. Touch your desired PTY preset key to select the program type.
5. Touch **[PTY Select]** button to return to the previous screen.

Changing the PTY language

1. Touch the **[List]** key.
2. Touch the **[PTY Select]** key.
3. Touch the **[PTY Lang.]** key to display the PTY language screen.



4. Touch the desired Language key.
5. Touch the **[PTY Lang.]** button again to return to the previous screen.

PTY Seek

1. Touch the **[List]** key and **[PTY Select]** key.
2. Touch the **[P-Seek Up]** or **[P-Seek Down]** key to Seek the frequencies up or down.

DVD Video Player Operations

Change DVD System Settings

Note:

If the set up operation is performed in the middle of DVD video play, the disc will restart from the beginning.

Selecting DVD Set Up Menu

1. Touch the **[Settings]** key on the Main Menu to access the Video set up menu.
2. Touch the **[Video]** key. The video menu is displayed.

Setting up the Screen Size

1. Touch the **[Aspect Ratio]** key in the **Video** sub menu to change the screen size.
 2. Touch the desired aspect ratio: **4:3** or **16:9**. The factory default setting is "**16:9**".
- When watching a wide type through a conventional type of the rear view monitor (4:3), the leftmost and rightmost areas of the screen are cut off.

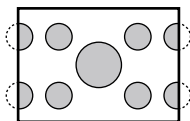

This function allows displaying the important part of image fully on the screen. In some cases, image is displayed while being panned (scrolled).

- When watching a wide type through a wide type of the rear view monitor (16:9), the leftmost and rightmost areas of the screen are not cut off.

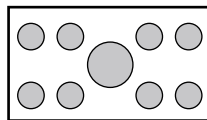

Setting up the Video System Format

1. Touch the **[Aux IN]** key in the **Video** sub menu to set up the video system format.
2. Touch the required format: **Auto**, **PAL** or **NTSC**.
The default setting is **Auto**.

Setting up the AUX Input Sensitivity

1. Touch the **[AUX Input SW]** key in the Video sub menu to set up the sensitivity level.
2. Touch the desired sensitivity level displayed: **Low**, **Mid** or **High**.
The default setting is **Mid**.

DVD Video Player Operations

Setting up the password for parental level control

The factory default password is "0000".

1. In **Main Menu** touch the **[Settings]** key.
2. Touch the **[Rating]** key on the display.
3. Touch the **[Set Password]** key, the numerical key pad will appear. Then input the default password and touch the **[OK]** key. It shows "New Password".

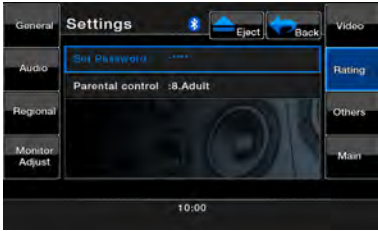

4. Touch the **[Set Password]** key again, the numerical key pad will appear. Input a new password and touch the **[OK]** key. Then it shows "Enter Password Again".
5. Touch the **[Set Password]** key for the third time, enter the same password as step 4. Then it shows "Locked" and the new password is set.

Note: When a disc with view restrictions is inserted, you will be prompted to input a password. The disc will not be viewable until the correct password is entered.

Set rating for parental level control

1. Touch the **[Settings]** key in the Main Menu.
2. Touch the **[Parental Control]** key in the **Rating** sub menu. The Parental Control selections will appear.
3. Touch the desired rating for level control. Use this table to set the parental level.

Kid Safe	SAFE FOR KID
G	GENERAL AUDIENCES
PG	PARENTAL GUIDANCE SUGGESTED
PG13	PARENTS STRONGLY CAUTIONED
PG-R	PARENTAL GUIDANCE RESTRICTED
R	RESTRICTED
NC-17	NO ONE 17 AND UNDER ADMITTED
Adult	ONLY ADULT ADMITTED

- The contents that the parental level restricts vary with the country code.

Note: The rating can be selected only under the password unlocked status, and the limits can be set only under the password locked status.

Watching/Listening to a disc

Note: Refer to the diagram in "CONTROLS" chapter.

To load a disc:

1. Press the **[OPEN/CLOSE]** button to retract the control panel. (VZ401E only)
2. Insert the disc into the center of the insertion slot the label side facing up.

CAUTION

For your safety, the driver should not insert or eject a disc, or operate the controls while driving.

Note:

- Never insert foreign objects into the disc insertion slot.
 - If the disc is not inserted easily, there maybe another disc in the mechanism or the unit may require service.
 - 8cm (single play) discs cannot be used.
3. Disc starts playing automatically.

WARNING

Some videos may be recorded at higher than desired volume levels. Increase the volume gradually from the minimal setting after the video has started.

Ejecting a disc

1. Touch the center of the screen.
2. Touch the **[Eject]** key.

*If the disc is left in the ejected position for 10 seconds, the disc is automatically reloaded. In this case, the play mode will remain set to the Tuner mode.

Note: If you force a disc into before auto reloading, it will damage the player.

DVD Video Player Operations

Showing DVD Player mode screen

After disc is loaded, the play mode is automatically engaged. Touch the screen of the playing disc to display DVD Video menu. The display will return to the playback screen, if you do not touch the screen for 25 seconds.

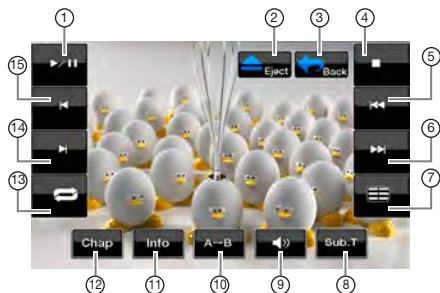

- | | |
|---------------------------|-------------------------|
| 1 - Play/Pause key | 9 - Audio key |
| 2 - Eject key | 10 - Repeat Segment key |
| 3 - Main Menu key | 11 - Information key |
| 4 - Stop key | 12 - Chapter key |
| 5 - Previous Playback key | 13 - Repeat key |
| 6 - Next Playback key | 14 - Fast Forward key |
| 7 - Title List key | 15 - Fast Backward key |
| 8 - Subtitle List key | |

Stop Playback

1. Touch the [■] key. Playback is stopped.
2. To resume playback, press the [▶/||] key. Playback resumes from the scene where playback is stopped.

Play/Pause Playback

1. Touch the [▶/||] key to pause during playback.
2. Touch the [▶/||] key again to resume playback.

Skip (Search) a Chapter

1. Touch the [◀◀] or [▶▶] key during playback. Chapters are skipped down or up from current locations, as many times as the key is pressed, and playback starts.

Fast Forward Fast Backward

1. Touch the [▶▶] or [◀◀] key to start your fast backward or fast forward during playback. The playback speed starts at 2x, then will increase to 4x, 8x, and 16x with each additional press.
*No audio is reproduced during fast forward and fast backward operation.
*The fast forward and fast backward speed may differ depending on the disc.

Direct Search Options

You can locate the beginning of a scene using the time, chapter numbers or title numbers recorded on the DVD Video disc.

1. Showing the DVD PLAYER mode screen, touch the [Chap] key.
2. The Direct Search Option menu appears with the search options that are available:
 - **Title**
A large segment to divide the data area of the disc.
 - **Chapter**
A small segment to divide the data area of the disc.
 - **Time**
A specific time on the disc.
3. Touch the Direct Search method you would like to use.
4. Input the number of the title/chapter/time that you want to play back with the numeric key.
5. Touch the [OK] key to confirm.

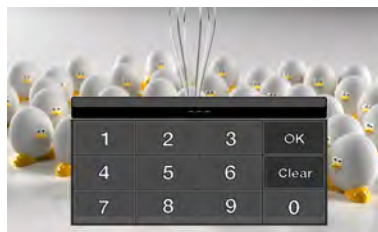

Playback starts from the scene of the input title number, time or chapter number.
*If the input title/chapter/time number does not exist or searching with a title/chapter number is not allowed, the screen image will not change.

DVD Video Player Operations

Repeat Playback

This operation plays back chapters recorded on the DVD Video repeatedly.

1. Showing the DVD Player mode screen, touch the [⏮] key for Chapter Repeat.
2. Touch the [⏮] key again for Title Repeat.
3. Touch the [⏮] key again to turn off the repeat playback.

Repeat A → B

Select the desired passage to play back.

1. Touch the [A → B] key to select the Repeat loop starting position.
2. Touch the [A → B] key again to select the Repeat loop ending position. The Repeat loop will begin.
3. Touch the [A → B] key again to stop replay.

Using the Title Menu

On DVD discs containing two or more titles, you can select from the title menu for playback.

1. Showing the DVD Player mode screen, touch the [≡] key during playback. The title menu appears.
* Depending on the disc, the title menu cannot be called.
2. Select the desired menu item using the Cursor-Key according to the menu contents.
3. Touch the [ENT] key to specify the selected menu item.
4. Touch the [Back] key to hide the Key Pad panel.

Switching Key Pad position

When the menu items become difficult to view by the Key Pad buttons, you can touch the [Left] or [Right] key to move the Key Pad panel to the other side of the screen.

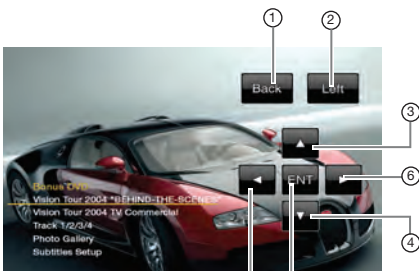

- | | |
|---------------------|----------------------|
| 1 - Back key | 5 - Select Left key |
| 2 - Left key | 6 - Select Right key |
| 3 - Select Up key | 7 - Enter key |
| 4 - Select Down key | |

Switching among the languages

On discs in which two or more audios or audio languages have been recorded, you can switch among the audio languages during playback.

1. Touch the [⏮] audio key during playback.
 - Each time you touch the key, you can switch among audio languages.
 - It may take time to switch among audios.
 - * Depending on the disc, up to 8 audios may be recorded. For details, see the mark of the disc: (8) Indicates that 8 audios have been recorded.
 - * When the power is turned on and when the disc is changed to a new one, the language set as the factory default is selected. If that language has not been recorded, the language is specified on the disc.
 - * Depending on the disc, switching may be completely impossible or impossible on some scenes.
2. The DVD PLAYER mode screen will hide in 3 seconds after your selection is made.

Switching Subtitles

On DVD discs in which two or more subtitle languages have been recorded, you can switch among the subtitle languages during playback.

1. Touch the [Sub T.] key during playback. Each time you touch the key, you can switch among subtitles.
 - It may take time to switch among subtitles.
 - * Depending on the disc, up to 32 kinds of subtitles may be recorded. For details, see the mark of the disc: (32) Indicates that 8 kinds of subtitles have been recorded.
 - * Depending on the disc, switching may be completely impossible or impossible on some scenes.
2. The DVD Player mode screen will hide in 3 seconds after your selection is made.
3. To turn off subtitles, repeat touching the [Sub T.] key until subtitles are turned off.

Switching angles

On DVD discs in which video images have been recorded in two or more angles, you can switch among the angles during playback.

1. Press the [ANGLE] button on the remote control during playback. Each time you press the key, you can switch among angles.
 - * It may take time to switch among angles.
 - * Depending on the disc, up to 9 angles may be recorded. For details, see the mark of the disc: (9) Indicates multi-angle.

DVD Video Player Operations

- * Depending on the disc, angles may switch smoothly or switch with a momentary still image.
- * Depending on the disc, switching may be completely impossible or impossible on some scenes.
- * Depending on the disc, scenes recorded in two or more angles may be played back.

Displaying the playback status

Touch the **[Info]** key on the DVD Player mode screen to display the playback status.

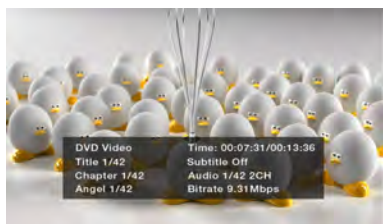

LISTENING TO a CD



- | | |
|------------------------|--------------------------------------------|
| 1 - Play/Pause key | 9 -Fast Forward key |
| 2 - Eject key | 10 -Fast Backward key |
| 3 - Main Menu key | 11 -Media Information |
| 4 - Stop key | 12 -User (Name, Artist, Album) Information |
| 5 - Previous Track key | 13 -Track Play number |
| 6 - Next Track key | 14 -Track Play time |
| 7 - Audio Settings key | |
| 8 - List key | |

Pausing Playback

1. Touch the **[▶/||]** key to pause playback.
2. To resume playback, touch the **[▶/||]** key again.

Skipping a Track (searching)

Touch the **[◀◀]** or **[▶▶]** key during playback. Tracks are skipped as many times the key is pressed, and playback starts.

- Pressing the **[▶▶]** key starts playback from the beginning of the next track.
- Pressing the **[◀◀]** key starts playback from the beginning of the current track. When this key is pressed again within about 2 seconds, playback starts from the beginning of the previous track.

Fast Forward and Fast Backward

1. Touch the **[▶]** or **[◀]** key during playback. The media will advance at 2x speed.
2. Touch again to advance to higher speed reversing or forwarding such as 4x, 8x and 16x. Touch once more to resume normal speed playback.

Scanning the Tracks

1. Touch the **[List]** key to display the Disc List screen.
2. Touch the **[Scan]** key to begin previewing the first 10 seconds of each song on the disc.

Searching with the Track Number

This operation allows searching using the track numbers recorded on the CDs.

1. Touch the **[List]** key to display the Disc List screen.
2. Touch the **[Key]** key to display the numerical keypad.
3. Input the track number that you want to play back with numerical keypad.
4. Touch the **[OK]** key to confirm.
 - If the input track number does not exist or searching with a track number is not allowed, the unit will return to the List screen.

Selecting a track on the Track List Screen

This function allows you to select tracks from a displayed list.

1. Touch the **[List]** key to display the Disc List screen.
2. Touch the track title on the display list. The selected track will start playing.
3. When the desired track is not displayed, touch the **[▲]** or **[▼]** key to scroll the track list.
4. Touch the desired track title key in the List display. The corresponding track will start playback.

DVD Video Player Operations

5. Touch the **[List]** key to return to the main screen.

Stop Playback

1. Touch the **[■]** key to stop playback.

Audio Settings

1. Touch the **[Audio Settings]** key to enter Audio menu.

Other various play functions

1. Touch the **[List]** key to display the Disc Listscreen.
2. Touch the key of the function you want to play:
 - Repeat [↺]:** Touch once to start a single track repeat. To turn repeat off, press the same key again.
 - Repeat symbols are displayed in the info window above the song list.
 - Shuffle [⌘]:** Touch the key to shuffle the tracks during playback. Touch the key again to turn off the feature.
 - A shuffle symbol is displayed in the info window above the song list.

LISTENING TO MP3/WMA

This unit is an ID3 Tag compatible model. This unit supports the ID3 TAGs of the Version 2.4, 2.3, 1.1 and 1.0. In displaying, this unit gives priority to the Version 2.3 and 2.4 TAGs. After USB device inserted into USB slot, or disc is loaded, the play mode is automatically engaged.

What is MP3/WMA?

MP3 is an audio compression method and classified into audio layer 3 of MPEG standards. WMA is an audio compression method developed by Microsoft Corporation. These audio compression methods have penetrated into PC users and become a standard format.

These features compress the original audio data to about 10 percent of its initial size with a high sound quality. This means that about 10 music CDs can be recorded on a CD-R disc or CD-RW disc to allow a long listening time without having to change CDs.

Note:

- Some CDs recorded on CD-R/RW mode may not be usable.

Displaying MP3/WMA TAG titles

Tag information such as title, artist and album title can be displayed for MP3/WMA file containing Tag information.

Precautions when creating MP3 disc

- **File extensions**
 1. Always add a file extension “.MP3” or “.mp3” to an MP3 file, and “.WMA” or “.wma” to a WMA file by using single byte letters. If you add a file extension other than specified or forget to add these file extension, the file cannot be played. In addition, if you use upper case and lower case letters (capital and small letters) mixedly for file extensions, normal play may not be possible.
 2. Files other than MP3/WMA data cannot be played.
 - Playing files with a format not supported will be skipped, and the scan, random and repeat playback mode may be canceled.
- **File and Disc Not Supported**

Files and discs with following extensions are not supported: *.AAC, *.DLF, *.M3U, *.PLS, MP3 PRO files, files with DRM, open session discs.
- **Logical format (File system)**
 1. When writing an MP3/WMA file on a disc, please select “**ISO9660 level 1 or level 2 (without including expansion format)**” as the writing software format. Normal playback may not be possible if the disc is recorded on another format.
 2. The folder name and file name can be displayed as the title during MP3/WMA play but the title must be within 31 single byte alphabetical letters and numerals for the folder name and file name (including an extension). Entering more letters or numeral than specified may cause an incorrect display.
- **Entering File and Folder Names**

Names using the code list characters are the only file names and folder names that can be entered and displayed. Using any other character will cause the file and folder names to be displayed incorrectly.
- **Electronic Shock Protection**
 - 10 seconds for CD-DA (CDA)
 - 45 seconds for MP3 recorded at 44.1 kHz, 128kbps
 - 90 seconds for WMA recorded at 44.1 kHz, 128kbps

- **Folder structure**

A disc with a folder having more than 8 hierarchical levels will conflict with the ISO9660 and playback will be impossible.

- **Number of files or folders**

1. The maximum allowable number of folders is 200 (including root directory); the maximum allowable number of files is 1500 (max. 1500 per folder). This represents the maximum number of tracks that can be played back.
2. Tracks are played in the order that they were recorded onto a disc. (Tracks might not always be played in the order displayed on the PC).
 - Some noise may occur depending on the type of encoder software used while recording.
 - In case of a track recorded at VBR (variable bit rate), the display for the play time of the track may be slightly different from the actual play time. Also, the recommended value of VBR ranges from 32 kbps to 320 kbps.
 - After disc selection, the play mode is automatically engaged.

DVD Video Player Operations

Playing MP3 folders

When selected for play, files and folders (Folder Search, File Search or Folder Select) are accessed in the order in which they were written to the media. As a result, the order in which they are expected to be played may not match the order in which they are actually played.

You may be able to set the order in which MP3/WMA files are to be played by assigning file names beginning with play sequence numbers such as "01" to "99".

For example, a medium with the following folder/ file hierarchy is subject to Folder Search, File Search or Folder Select.

See the diagram below.

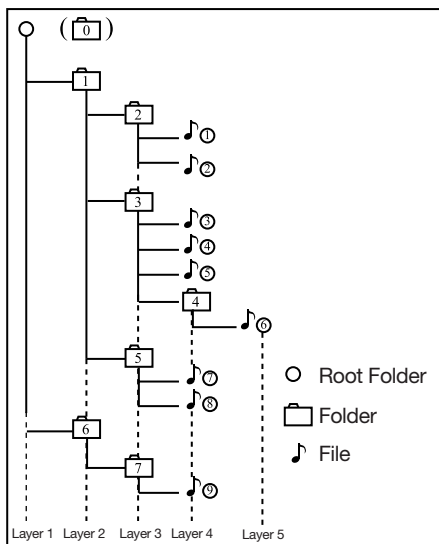

The player will only recognize three folder levels and does not display folders containing other folders. In the example above, the unit will display folders 2, 3, 5, and 7, but not 1 and 6 since they do not contain others.

Playing DivX file

This system can playback DivX movie files recorded on a disc.

- Official DivX® Certified product
- Plays all versions of DivX® video (including DivX® 6) with standard playback of DivX® media files.

What is DivX?

DivX is a popular media technology created by DivX, Inc. DivX media files contain highly compressed video with high visual quality that maintains a relatively small file size. DivX files can also include advanced media features like menus, subtitles, and alternate audio tracks. Many DivX media files are available for download online, and you can create your own using your personal content and easy-to-use tools from DivX.com.

7. ACCESSORIES

iPod/iPhone Operations

iPod/iPhones can be connected by using the connector cable supplied with the iPod/iPhone, but in this case, you can enjoy its audio sound only. To enjoy video movies stored in the iPod/iPhone with video displaying them on this unit, it is required to use the special connector cable (CCA-748) separately sold.

Note:

- This system will not operate or may operate improperly with unsupported versions.
- For detailed information on the playable iPod/iPhone models, see our home page: www.clarion.com

Notes on using Apple iPod/iPhone

- Do not connect an iPod/iPhone to this unit with a headphone connected to the iPod/iPhone.
- After the iPod/iPhone has been connected to this unit, the iPod's buttons are disabled for operation in the Music mode.
- In the Video mode, do not operate the iPod's buttons.
- When in the iPod mode, a special iPod/iPhone control screen is displayed different from the main screens for other modes.
- When no data is present, the title display will remain blank.
- The iPod/iPhone is used with the equalizer function turned OFF.
- Set the iPod/iPhone's language setting to English before connecting your iPod/iPhone. Some characters of the other languages may not be displayed correctly in this system.
- **Precautions on battery consumption:**
If the iPod/iPhone is connected to this unit when the iPod/iPhone's internal battery has run down, this function may not operate correctly. You must connect the iPod/iPhone after charging the battery if it has run down.

Selecting the iPod Mode

1. Connect your iPod/iPhone to the USB connector. The system will automatically detect the connected device. The iPod icon is displayed on the Main Menu screen.



- **When a iPod/iPhone is already connected**

Touch the **[iPod]** key on the Main Menu screen. The system changes to the iPod mode, and starts playback from the previous position.

Controlling the iPod/iPhone

Operation keys

- iPod audio mode screen



- | | |
|------------------------|-----------------------|
| 1 - Play/Pause key | 6 -Next Track key |
| 2 - Eject key | 7 -Audio Settings key |
| 3 - Main Menu key | 8 -List key |
| 4 - Video/Music key | 9 -Fast Forward key |
| 5 - Previous Track key | 10 -Fast Backward key |

[▶/⏸] Play/Pause key

- Use to control playback and pause.
 1. Touch the key during playback. Playback pauses.
 2. To resume playback touch the key again.

[Video] Video/Music key

- Touch this key to switch operation mode to the Video mode or Music mode.

iPod/iPhone Operations

Note:

- Note that not all iPod/iPhone devices are compatible to output video to this unit.

[◀] Previous Track key

- Touch this key to play the previous track.

[▶] Next Track key

- Touch this key to play the next track.

[Audio Settings] key

- Touch this key to switch to the Audio menu for setting the audio settings.

[▶▶] Fast Forward key

- Touch this key to fast forward the track selection.

[◀◀] Fast Backward key

- Touch this key to fast backward the track selection.

[List] key

- Touch the List key to display the menu screen to search tracks to be played.



- | | |
|---------------------|-----------------|
| 1 - Scroll Up key | 4 - Folders key |
| 2 - Scroll Down key | 5 - Repeat key |
| 3 - iPod Menu key | 6 - Shuffle key |

[▲] Scroll Up key

- Touch this key to scroll up the track list.

[▼] Scroll Down key

- Touch this key to scroll down the track list.

[iPod Menu] key

- Touch this key to return to the previous menu.

[Folders] key

- Touch this key to return to the main track search screen.

[Repeat] key

- Touch this key to repeat the play of the selected track.

[Shuffle] key

- Touch this key to shuffle between the tracks.

Viewing video data in the iPod/iPhone (only for the iPod/iPhone with video features)

When you connect an iPod/iPhone with video features by using the optional connector cable for iPod/iPhone with video, you can enjoy the video data and slide show data stored in the iPod/iPhone showing them on the display of this unit (and the rear monitor if connected).

Note:

Do not connect the iPod/iPhone to this unit when a Video Playlists item is selected on the iPod/iPhone.

1. Touch the [Video] key on the iPod audio mode menu screen. The iPod play video screen is displayed.
2. Select the type of video you would like to play, by touching the menu. The video playback will start.

Note:

- Video playback is not available on all iPod/iPhone devices. Please contact your Clarion dealer for details. An optional connection cable or accessory may be required for this feature.

3. To stop the video play, touch the screen. iPod play video menu will be displayed.

4. Touch the [Music] key to return to the iPod audio menu.

Note:

- "AUDIO ONLY" is displayed when the automobile is moving.
- Image data may not be played back according to the status of the iPod/iPhone.
- The volume setting of video data is relatively lower than audio data. Be sure to lower the volume setting before switching to the other mode.
- Do not select the categories with no track registered from the iPod menu screen. The iPod/iPhone may be frozen. If the iPod/iPhone is frozen, reset the iPod/iPhone by following the procedure described in the instruction manual of the iPod/iPhone.
- Audio may be played back slightly out of synchronization with video images.

USB Operations

This system can play audio files (MP3/WMA) stored in an USB memory which is recognized as "USB Mass Storage Class device". You can use your USB memory as an audio device by simply copying desired audio files into it.

Note:

- This system will not operate or may operate improperly with some USB memory.
- Files protected with any DRM can not be played.

Notes on using USB memories

• General notes

- When no data is present, the message "NO FILE" will be displayed.

• Notes on the MP3/WMA files

- This system can play the MP3/WMA files stored in the USB memory.
- Set the Sampling Frequency to:
 - For MP3 files:
 - MPEG1 Layer3: 32, 44.1, or 48 kHz
 - MPEG2 Layer3: 16, 22.05, or 24 kHz
 - MPEG2.5 Layer3: 8, 11.025, or 12 kHz
 - For WMA files: 32, 44.1, or 48 kHz
- Set the Bit Rate to:
 - For MP3 files:
 - MPEG1 Layer3: 32 to 320 kbps (VBR)
 - MPEG2 Layer3: 16 to 160 kbps (VBR)
 - MPEG2.5 Layer3: 16 to 160 kbps (VBR)
 - For WMA files: 32,48, 64, 80, 96, 128, 160, or 192 kbps
- Add the following file extension using single byte characters:
 - For MP3 files: ".MP3" or ".mp3"
 - For WMA files: ".WMA" or ".wma"

• Notes on the folder structure

- The folder hierarchy must be within 8 hierarchical levels. Otherwise, playback will be impossible.
- The maximum allowable number of folders is 200 (including root directory and folders with no MP3/WMA file).
- The maximum allowable number of files in a folder is 1500.
- The maximum allowable number of files in all folders is 1500.
- You can store the MP3 files, WMA files together in a folder.

• Notes on the Tag titles

The limitations on the Tag titles are same as those in the MP3/WMA modes.

• Folder representation in the folder list

The limitations on the folder representation are same as those in the MP3/WMA modes.

Selecting the USB Memory Mode

Connect your USB memory to the USB connector. Touch the **[USB]** key to select the USB on the Main Menu screen.

The system changes to the USB mode and starts playback.

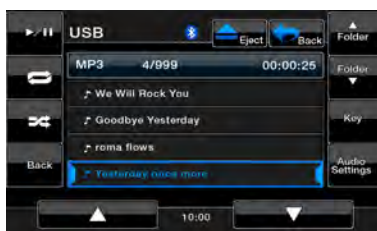
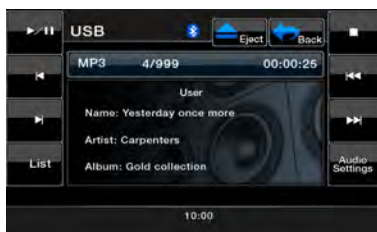

Playing Back Files in the USB Memory

The operations in the USB Memory mode are same as those in the MP3/WMA modes. See "Listening to a CD" for details.

Bluetooth Audio Player Operations

Some Bluetooth cellular phones have the audio features, and some portable audio player support the Bluetooth feature. These devices will be called as "Bluetooth audio players" in this manual. This system can play audio data stored in a Bluetooth audio player.

Note:

- This system will not operate or may operate improperly with some Bluetooth audio players.
- For detailed information on the playable Bluetooth audio players, see our home page: www.clarion.com

This unit has a Bluetooth indicator (📶) on the top of the screen.

When the Bluetooth function is "OFF", the indicator is grey.

When the Bluetooth function is "ON" and the phone is not connected, the indicator will blink. If the phone is connected, the indicator is light up solid.

Selecting the Bluetooth Mode

1. Touch the (📶) Bluetooth indicator on the top of the screen.
Touch the [📶 Bluetooth] key in the Main Menu screen to access the Bluetooth mode directly. The default setting is OFF.
2. The system changes to the Bluetooth mode.

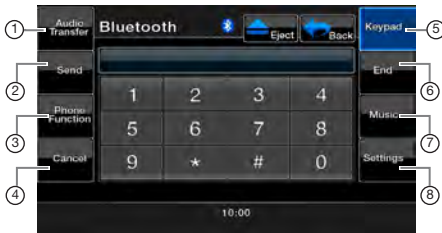

- | | |
|------------------------|----------------|
| 1 - Audio Transfer key | 5 - Keypad key |
| 2 - Send key | 6 - End key |
| 3 - Phone Function key | 7 - Music key |
| 4 - Cancel key | 8 - Settings |

[Audio Transfer] key

- While talking, to transfer audio from the unit back to the mobile, touch the key. You can only transfer a call after it has been answered. Touch the key again to transfer the call back to the head unit.

[Send] key

- Touch this key to answer an incoming call or to make a call.

[Phone Function] key

- Touch this key to access the phone book

[Cancel] key

- Touch this key to backspace.

[Keypad] key

- Touch to access the numerical pad channel.

[End] key

- Touch this key to reject an incoming call or to end a call.

[Music] key

- Touch to access the Bluetooth music function.

[Settings] key

- Touch this key to access the Bluetooth Setting

Registering your Bluetooth Device (Pairing)

You can register up to 1 Bluetooth device.

The required password to pair the phone to the unit is "1234".

1. Touch the [Settings] key on the screen.
2. Touch the [Pair mode] key on the Settings screen.
3. Touch the [Pairing] key to begin the pairing process.



4. The cellular phone may prompt to acknowledge the Bluetooth connection and to enter the Pass Key code of this unit. Perform these operations according to the message displayed.
5. When the pairing operation is completed, the registered Bluetooth device is set as current. Bluetooth Indicator is light up solid.



Bluetooth Audio Player Operations

Note:

- You cannot register the same Bluetooth audio player which is already registered doubly.

Controlling the Bluetooth Audio Player

Note:

- Occasionally, depending on the environment, playback sounds may be fragmented, or switch noises may be generated.



- | | |
|-------------------------|----------------|
| 1 - [Fast Backward] key | 5 - [ON] key |
| 2 - [Fast Forward] key | 6 - [Stop] key |
| 3 - [Play/Pause] key | 7 - [OFF] key |
| 4 - [Fast Backward] key | |

Playing Music

After the connection with a Bluetooth audio player is established, the play mode is automatically engaged.

- When playback is not started, touch the [Play/Pause] key.

Pausing Playback

- Touch the [Play/Pause] key during playback. Playback pauses.
- To resume playback, touch the [Play/Pause] key. Playback resumes.

Skipping a Track (Searching)

- Touch the [Fast Backward] or [Fast Forward] key during playback. Tracks are skipped, as many as the times the key is touched, and playback starts.

Note:

- Control functions such as play, pause and track skipping are not available on all devices.

Fast Forward and Fast Backward

- Touch and hold the [Fast Backward] or [Fast Forward] key during playback. The system enters the fast backward or fast forward playback mode during touching the key. Releasing the key resumes the normal speed playback.

[ON]

- Touch this key to connect the music.

[OFF]

- Touch this key to disconnect the music.

Bluetooth Telephone Operations

Selecting the BT Phone mode

1. Touch the [**↩**] key to display the Menu screen.
2. Touch the [**Bluetooth**] key to select the Bluetooth mode.
3. Touch the [**Keypad**] key to select the BT Phone mode.

The Telephone screen is displayed.

- When the connection with a Bluetooth telephone has been established, the icon and signal level indicator are displayed at the top of the screen.

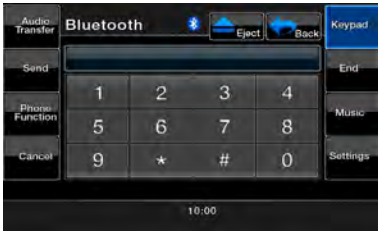

Setting the Telephone Features

1. Touch the [**Setting**] key to display the Telephone Settings screen.



2. Perform setting for the desired item.
See the following sections for detail.

Setting Automatic Connection

The system automatically reconnects the cellular phone after the connection is lost or the system is restarted.

- The factory default setting is "Manual".
Touch the [**Manual**] or [**Auto**] key of the Automatic [**Connect**] item to set the function preference.

Selecting Microphone

You can select the microphone to be used.

- The factory default setting is "Internal".
Touch the [**External**] or [**Internal**] key of the [**MIC Select**] item to set the function

Setting Microphone Gain

1. You can adjust the input level of the microphone in 6 levels.
 - The factory default setting is "3".

Note:

- The input level of the microphone can be affected by its surroundings. Adjust the level when the person on the other end of the telephone has a reception problem.
2. Touch the level indicator of the [**MIC Gain**] key to adjust the input level.

Note:

- You can talk with other party by using the internal microphone. When it is hard to hear for the other party in accordance with the communication condition or the used telephone, use the optional microphone (RCB-199), and set the Microphone Select setting to "External". The sound will be improved, but noises may still be heard depending on the communication condition.

Telephone operations

Note:

- For your safety, this system disables the calling functions when the car is moving. Be sure to stop the car and apply the parking brake before making a call.

Making a Call Using the Ten-Key Pad

1. Touch the [**Keypad**] key to display the Ten-Key pad screen.
2. Enter the telephone number by using the Ten-Key pad displayed on the screen.
3. Touch the [**Send**] key to call the entered number.
 - The following Telephone Interrupt screen is displayed during phone call.



- Touch the [**Audio Transfer**] key to talk using the cellular phone canceling the hands-free function.
To return to the hands-free mode, touch the [**Audio Transfer**] key.

Bluetooth Telephone Operations

- When the call is finished, touch the **[End]** key to hang up. The display will return to the previous mode screen selected before entering the BT Phone mode.

Note:

- Depending on the cellular phone, the Telephone Interrupt screen may be closed and the connection with this system may be disconnected when entering the Private mode.

Obtaining the Phone Book Data

Sending the Phone Book data from the cellular phone enables you to make a call using the Phone Book function from this unit.

- Perform the Object Push transfer operation of the Phone Book data on the current cellular phone.
For details of the operation, see the operation manual of the cellular phone.

Note:

- Some cellular phones may not be able to transfer the Phone Book data.
- The Phone Book data transmission may take a long time. The operations of sending calls are disabled during the data transmission.
- Some cellular phones cannot transfer the Phone Book data when the hands-free mode is set or it is also registered in the Bluetooth mode. In those cases, disable these functions from the cellular phone before performing the Object Push transfer.
- Some cellular phones may transfer Phone Book data automatically.

Making a Call Using the Phone Book

You can use the Phone Book data obtained from the cellular phone to make a call from this unit.

Note:

- Before using this function, the Phone Book data must be sent from the cellular phone
 - Only the Phone Book items with at least one telephone number registered in the captured Phone Book data are displayed on the Phone Book screen.
- Touch the **[Phone Function]** key to display the Phone Log screen.
 - Select **[My Phonebook]** or **[SIM Phonebook]** to select your desired phonebook to view.

- Touch the desired Name key you wish to dial. Touch the **[▲]** or **[▼]** key to scroll the list. When you touch the alphabet key at the right of the screen, the list scrolls to the item which starts with the specified character.
- Touch the desired selection you wish to dial. When the call is finished, touch the **[End]** key to hang up.

Making a Call Using the History

The system will recall the Dialed/Received calls record data in the handset memory. You can confirm it and use it to make a call from this unit.

- Touch the **[Phone Function]** key. The History List screen is displayed.
- Select **[Dialed Call]**, **[Received Call]** or **[Missed Call]** key to select your desired call log.
 - Touch the **[▲]** or **[▼]** key to scroll the list.
 - Touch the **[Phone Function]** key to return to the previous screen.
- Touch the desired History item key you wish to dial. When the call is finished, touch the **[End]** key to hang up.

Answering to an Incoming Call

When a call comes in, the following Telephone Interrupt screen appears.



You can answer to the incoming call on this system by the following operation.

- Touch the **[Send]** key to answer to the call. When the call is finished, touch the **[End]** key to hang up.

AUX In / AV In Operations

External peripheral devices, including a game console, camcorder, video of iPod/iPhone, etc, can be connected to the AUX IN in the front of this unit or AV IN connector on the back of this unit using the A/V media cables.

⚠ WARNING

For your safety, the driver should not watch the VTR, etc. or operate the controls while driving. Please note that watching and operating the VTR, etc. while driving are prohibited by law in some countries.

NOTE:

For your safety, the unit has a safety function, which turns off the picture when car is moving, so only the audio can be heard. The picture can be only watched, when the car is stopped and parking brake is applied.

Switching to AUX IN / AV IN mode

Touch **[AUX IN]** or **[AV IN]** key on Main Menu to select desired mode (when unit is reading). The LCD will display the external video.

The screen will display “No Video” menu, if there is no video signal.

You cannot directly control external devices connected to the AUX IN or AV IN input.



Camera In Operations

Switching to Camera mode

Touch **[Camera]** key on Main Menu to select desired mode. The LCD will display the external video. The screen will display “No Video Signal” menu, if there is no video signal.



When the video signal is displayed, touch the center of the screen to return to the Main Menu.

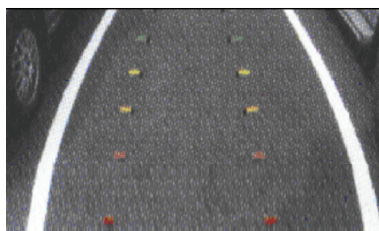

Setup Operations

You can customize the various settings of this unit from the Settings screen.
Touch **[Settings]** key on the Main Menu screen. The Setting menu screen will be displayed.
Touch the **[Main]** key to return to the Main screen.

General Settings

1. Touch the **[General]** key. The general setting screen appears. The screen includes: Clock, Clock Mode, Radio, and Version.
2. Touch the desired tab key and perform the basic adjustments.
 - **Setting the Clock**
Touch this tab to set the time.
The keypad will appear for adjustment.
Touch the **[OK]** key to save.
 - **Setting the Clock Mode**
Touch this tab to change to 12Hr or 24Hr mode.
 - **Version**
This tab displays the software version of your unit.

Audio Settings

1. Touch the **[Audio]** key to set: Bass Freq, Treble Freq, and Bass Q-Factor.
2. Touch the desired tab key to make the desired audio adjustments.
 - **Bass Freq**
Select the desired bass center adjustment frequency: 60Hz, 80Hz, 100Hz, 200Hz
 - **Treble Freq**
Select the desired treble center adjustment frequency: 10KHz, 12.5KHz, 15KHz, 17.5KHz
 - **Bass Q-Factor**
Select the desired bass Q-Factor: 1.0, 1.25, 1.5, 2.0.

Regional Settings

1. Touch the **[Regional]** key to set the default subtitle and audio language preferences.
2. Touch the desired tab key and perform the adjustments.
 - Select the desired audio/subtitle language: **English, German, French, Italian, Spanish, Swedish, Dutch, Polish, Greek or Russian.**
 - Select **Auto** to automatically set the language. Select **Off** to turn the desired function off.

Monitor Adjust Settings

1. Touch the **[Monitor Adjust]** key to set: Touch Screen Calibration, Brightness, TFT Angle and TFT Auto Open.
2. Touch the desired tab key and perform the necessary adjustments.
 - **Touch Screen Calibration**
This key is to activate the touch screen activation mode, please consult technical support before attempting this process.
 - **Brightness**
Set screen brightness value from 0 to 20.
 - **TFT Angle (VZ401E)**
Adjust the TFT angle from 0 to 5.
 - **TFT Auto Open (VZ401E)**
When it is On and the ACC power on, the TFT opens automatically.

Video Settings

1. Touch the **[Video]** key to set: Aux In Sensitivity, Aux In Format, and Aspect Ratio.
2. Touch the desired tab key and perform the adjustments.
 - **Aux In Input SW**
Select the **Low, Mid or High** for the Aux In input sensitivity level.
 - **Aux In**
Select the video format for Aux In signal.
Select from **Auto, PAL or NTSC.**
 - **Aspect Ratio**
Select the screen area shape: **4:3 or 16:9.**

Rating Settings

1. Touch the **[Rating]** key to set: Password, DVD Parental control rating.

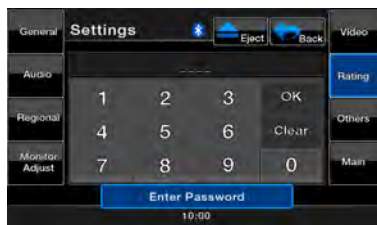

2. Touch the desired tab key and perform the adjustments.
 - **Password**
Refer to Setting up the password for parental level control in page 24.

Setup Operations

• Parental control

Touch this key to set the age ratings
Choose the desired rating:
1. Kid Safe, 2. G, 3. PG, 4. PG-13,
5. PG-R, 6. R, 7. NC-17, 8. Adult.

The Others Settings

1. Touch the key to set: Anti-theft code, Anti-theft, Bluetooth, Tel SP, Blinking, Beep and Reset.
2. Touch the desired tab key and perform the adjustments.

• Anti-theft code

If your unit is unlocked, touch this tab to change your anti-theft code. The numerical keypad is displayed, enter the right code to unlock, and it displays “_ _ _ _”. Touch again and enter the new code twice, then the code is set and your unit is locked. If your unit is unlocked, enter your code. Touch the **[OK]** key to save it.

• Anti-theft

Touch this tab to turn **On** or **Off** the anti-theft lock function. Turn on the Back up when the Anti-theft is On, you need enter the right Anti-theft code to turn on the unit normally.

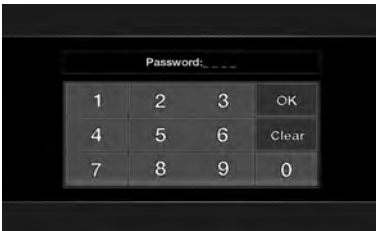

If you enter the wrong code for four times, the unit will be locked, and must be unlocked by the professionals.

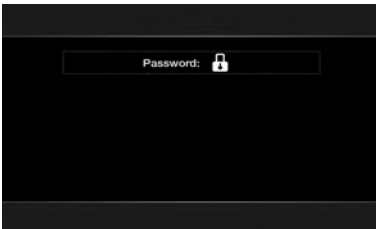

• Bluetooth

Touch this tab to turn **On** or **Off** the Bluetooth.

• Tel SP

Touch this tab to set the output speaker for the Bluetooth feature. You may select the **Left Front speaker** or **Right Front speaker**.

• Blinking

Touch this tab to turn the anti-theft blinking indicator **On** or **Off**. When the Blinking is On and the ACC power is off, the indicator blinks red.

• Beep

Touch this key to turn **On** or **Off** the beep sound.

• Reset

Touch this key to reset the unit to default settings except Anti-theft.

8. TROUBLESHOOTING

GENERAL

Problem	Cause	Measure
Power does not turn on. (No sound is produced.)	Fuse is blown.	Replace with a fuse of the same amperage. If the fuse blows again, consult your store of purchase.
	Incorrect wiring.	Consult your installation center.
Nothing happens when buttons are pressed. Display is not accurate.	The microprocessor has malfunctioned due to noise, etc.	Press the reset button with a thin rod. Note: <i>When the Reset button is pressed, turn off the ACC power.</i> * When the Reset button is pressed, frequencies of radio stations, titles, etc. stored in memory are cleared.
The remote control unit does not work.	Direct rays of the sun fall on the light-receptive part of the remote control unit.	When direct rays of the sun fall on the light-receptive part of the remote control unit, it may not work.
	The battery of the remote control unit is dead or there is no battery in the remote control unit.	Check the battery of the remote control unit.

DVD PLAYER

Problem	Cause	Measure
Disc cannot be loaded.	A disc is already loaded.	Eject the disc before loading the new one.
	There is foreign matter already in the disc slot.	Remove the foreign matter, or consult a service station.
Sound skips or is noisy.	Disc is dirty.	Clean the disc with a soft cloth.
	Disc is heavily scratched or warped.	Replace with a disc in good condition.
Sound is bad directly after power is turned on.	Condensation may form on the internal lens when the car is parked in a humid place.	Let dry for about 1 hour with the power on.
Video images are not displayed.	The parking brake is not engaged.	Check that the parking brake is engaged.
Disc cannot play with the display " PARENTAL VIOLATION " shown.	Feature exceeds set parental level.	Release the view limitation or change the parental level. See the subsection "Setting up the parental level"

USB DEVICE

Problem	Cause	Measure
USB device cannot be inserted.	The USB device has been inserted with wrong direction.	Reversing the connection direction of the USB device, try it again.
	The USB connector is broken.	Replace with a new USB device.
USB device is not recognized.	The USB device is damaged.	Disconnect the USB device and reconnect. If the device is still not recognized, try replacing with a different USB device.
	Connectors are loose.	
No sound heard with the display "NO FILE" shown.	No MP3/WMA file is stored in the USB device.	Store these files properly in the USB device.
Sound skips or is noisy.	MP3/WMA files are not encoded properly.	Use MP3/WMA files encoded properly.
The iPod/iPhone's video image is disturbed.	The TV Signal setting of the iPod/iPhone is not set correctly.	Set the TV Signal setting (NTSC/PAL) of the iPod/iPhone correctly.

Bluetooth

Problem	Cause	Measure
Cannot pair the Bluetooth enable device with the car audio system.	The device does not support the profiles required for the system.	Use another device to connect.
	The Bluetooth function of the device is not enabled.	Refer to the user manual of the device for how to enable the function.
The audio quality is poor after connection with a Bluetooth enabled device.	The microphone is not correctly positioned.	Use optional external microphone and adjust the position of it.
	The Bluetooth reception is poor.	Move the device closer to the car audio system or remove any obstacle between the device and the system.

TV/VTR (When connecting an optional TV tuner, etc.)

Problem	Cause	Measure
The image is not displayed.	The parking brake is not engaged.	Check that the parking brake is engaged.
The display is dark.	The brightness control is too low.	Adjust the brightness properly.
	The operating condition is not good.	The temperature inside the vehicle may be 0 °C or lower. Set to an appropriate temperature (25 °C or so) and check it again.
	The headlight of the vehicle is lit	The display is made dark at night to prevent the glare (When the headlight of the vehicle is lit in the daytime, the display gets dark).
When the VTR is connected, the image is disturbed.	Improper NTSC/PAL setting	Set the AUTO/PAL/NTSC properly according to the VTR.
There are red, green, and blue points in display.	-----	This is not a failure, but a phenomenon peculiar to a liquid crystal panel (The liquid crystal panel is produced according to technology with very high precision. Note that, though there are effective pixels of 99.99% or more, pixel missing or normally lit pixels account for 0.01%).

9. ERROR DISPLAY

If an error occurs, one of the following displays is displayed.
Take the measures described below to solve the problem.

DVD PLAYER

Display	Cause	Measure
BAD DISC	A disc is caught inside the DVD deck and is not ejected.	This is a failure of DVD deck's mechanism and consult your store of purchase.
BAD DISC	A disc cannot be played due to scratches, etc.	Replace with a non-scratched, non-warped disc.
BAD DISC	A disc is loaded upside-down inside the DVD deck and does not play.	Eject the disc then reload it properly.
PARENTAL VIOLATION	Parental level error	Set the correct Parental level.
Disc Region incorrect	Region code error	Eject the disc, and replace correct region code disc.

If an error display other than the ones described above appears, press the Reset button. If the problem persists, turn off the power and consult your store of purchase.

* When the Reset button is pressed, frequencies of radio stations, titles, etc. stored in memory are cleared.

10. SPECIFICATIONS

FM Tuner

Frequency Range: 87.5 MHz to 108 MHz

Usable Sensitivity: 8 dB μ V

50dB Quieting Sensitivity: 14 dB μ V

Alternate Channel Selectivity: 70 dB

Stereo Separation: 25 dB (1 kHz)

Frequency Response: 30 Hz to 15kHz

AM Tuner

Frequency Range: 531 kHz to 1602 kHz

Usable Sensitivity: 28 dB μ V

DVD Player System

Digital Versatile Disc System with CDDA capable

Usable discs:

DVD video disc, Compact disc

Frequency Response: 20 Hz to 20 kHz

Sound/Noise Ratio: 87 dB(A (1W Ref)

Dynamic Range: 87 dB (1 kHz)

Distortion: 0.05%

Audio/Video Input

Audio input voltage: $\leq 2 V_{rms}$

Video input voltage: $1.0 V_{p-p} @ 75\Omega$

Audio input sensitivity (at 1V output)

High: $300mV_{rms}$

Mid: $600mV_{rms}$

Low: $1.3V_{rms}$

Audio/Video output

Video output voltage: $1.0V_{p-p} @ 75\Omega$

LCD Monitor

VX401E Screen Size: 6.2" wide type

Pixels: 1,152,000

Resolution: 800 x 480 x 3 (RGB)

VZ401E Screen Size: 7" wide type

Pixels: 1,152,000

Resolution: 800 x 480 x 3 (RGB)

Bluetooth

Specification: Bluetooth Ver 2.1+EDR

Profile:

HFP (Hands Free Profile)

HSP (Headset Profile)

A2DP (Advanced Audio Distribution Profile)

AVRCP (AV Remote Control Profile)

Power Class: 2

MP3 mode

Bit rate: 32 kbps to 320 kbps

Sampling rate: 32 kHz, 44.1 kHz, 48k Hz

WMA mode

Bit rate: 64 kbps to 192 kbps

Sampling rate: 32 kHz, 44.1 kHz, 48k Hz

USB

Specification: USB 1.1/2.0 (FS)

Playable audio format:

MP3 (.mp3): MPEG 2/Audio Layer-3

WMA (.wma): Ver 7/8/9.1/9.2

Audio amplifier

Maximum power output:

160W (40W x 4)

Speaker impedance:

4 Ω (4 to 8 Ω allowable)

General

Power source voltage:

14.4 V DC (10.8 to 15.6 V allowable)

Ground: Negative

Current consumption:

4.0 A @1 W

Auto Antenna Rated Current: 500 mA less

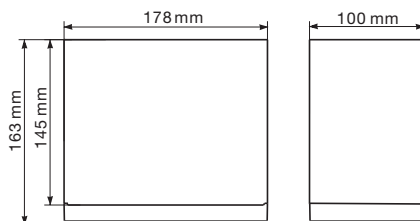
VX401E dimensions:

VX401E weight: 2.4 kg

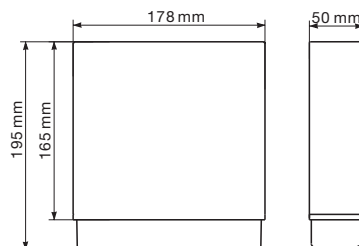
VZ401E dimensions:

VZ401E weight: 2.4 kg

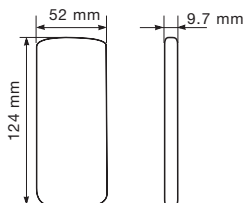
Remote Control dimensions:

Remote Control weight:

50 grams (including battery)

Note:

- Specifications comply with JEITA Standards.
- Specifications and design are subject to change without notice for further improvement.

INSTALLATION / WIRE CONNECTION GUIDE

CONTENTS

1. Before Starting.....	46
2. Package Contents	46
3. General Cautions	46
4. Cautions On Installation	47
5. Installing The Main Unit	48
6. Cautions On Wiring	50
7. Wire Connections	51

1. Before Starting

1. This set is exclusively for use in cars with a negative ground 12V power supply.
2. Read these instructions carefully.
3. Be sure to disconnect the battery “-” terminal before starting. This is to prevent short circuits during installation. (Figure 1)

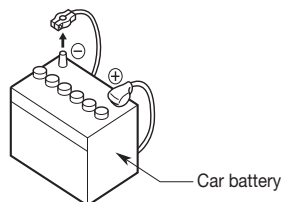

Figure 1

2. Package Contents

Main unit.....	1	2DIN trim ring 200mm wide (VX401E only)	1
Wiring harness.....	1	Mounting Bracket key (VZ401E only)	2
AV cable	1	Flush mount bolts (VX401E)	8
Remote control unit.....	1	(VZ401E)	4
Battery (CR2025).....	1	Hexagon Head Screw (VX401E)	8
(Installed in remote control)		(VZ401E)	5
Trim ring	1	Rear radio stud and stopper	1
Cleaning cloth	1		
Warranty Card	1		
Owner's manual.....	1		
Electro tap	1		

3. General Cautions

1. Do not open the case. There are no user-serviceable parts inside. If you drop anything into the unit during installation, consult your dealer or an authorized Clarion service center.
2. Use a soft, dry cloth to clean the case. Never use a rough cloth, thinner, benzene, or alcohol etc. For tough dirt, apply a little cold or warm water to a soft cloth and wipe off the dirt gently.

4. Cautions on Installation

1. Prepare all articles necessary for installing the source unit before starting.
2. This model features an operation panel that slides forward.

On some types of cars, the operation panel may make contact with the dashboard or gearshift lever, in which case it cannot be installed. Before installing, check that the unit will not hamper operation of the gearshift lever or obstruct your view before selecting the installation location. (Figure 2)

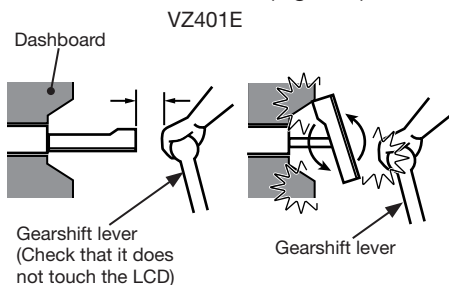

Figure 2

3. Install the unit within 30° of the horizontal plane. (Figure 3)

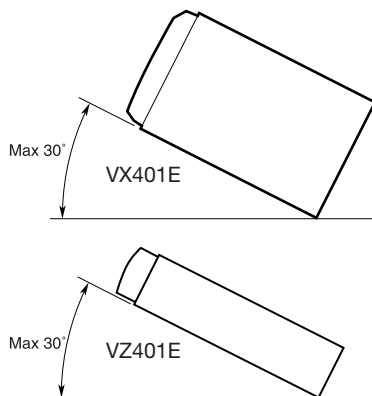

Figure 3

4. If you have to do any work on the car body, such as drilling holes, consult your car dealer beforehand.
5. Use the enclosed screws for installation. Using other screws can cause damage. (Figure 4)

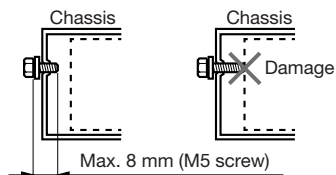

Figure 4

5. Installing the Main Unit

This unit is designed for fixed installation in the dashboard.

1. When installing the main unit in NISSAN vehicles, use the parts attached to the unit and follow the instructions in Figure 6. When installing the main unit in TOYOTA vehicles, use the parts attached to the vehicle and follow the instructions in Figure 7.

2. Wire as shown in Section 7.

3. Reassemble and secure the unit in the dashboard and set the face panel and center panel.

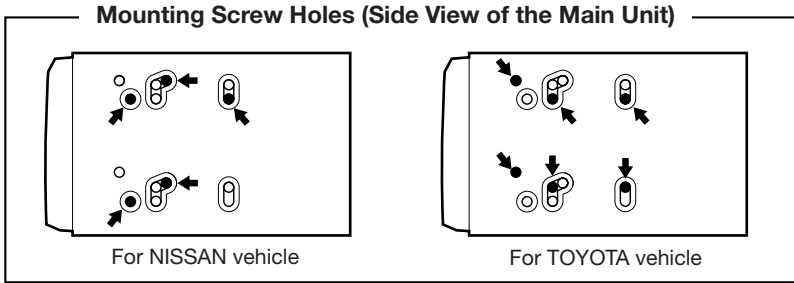

Figure 5

Installing the Main Unit in NISSAN Vehicle

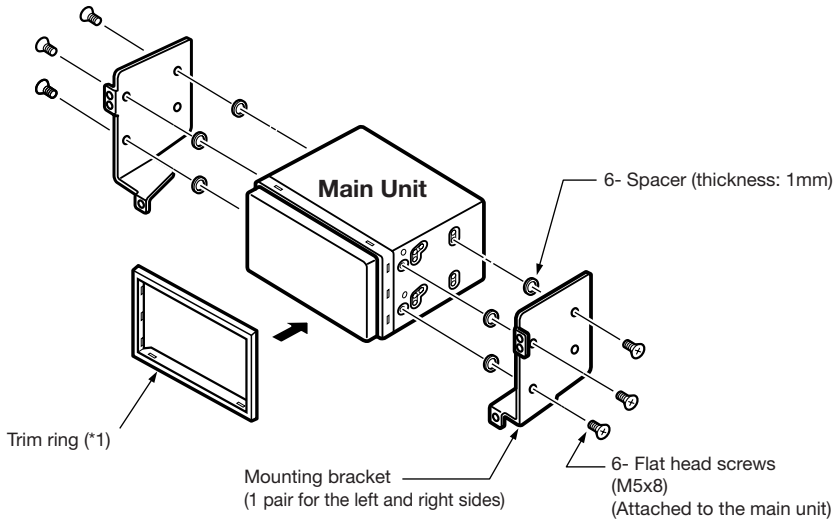

Figure 6

Note:

*1: Position the face panel with its wide edge at the bottom.
Fit the edge into the groove of the main unit.

Installing the Main Unit in TOYOTA Vehicle

Install by using parts attached to the vehicle. (Screws marked ★ are attached to the vehicle.)

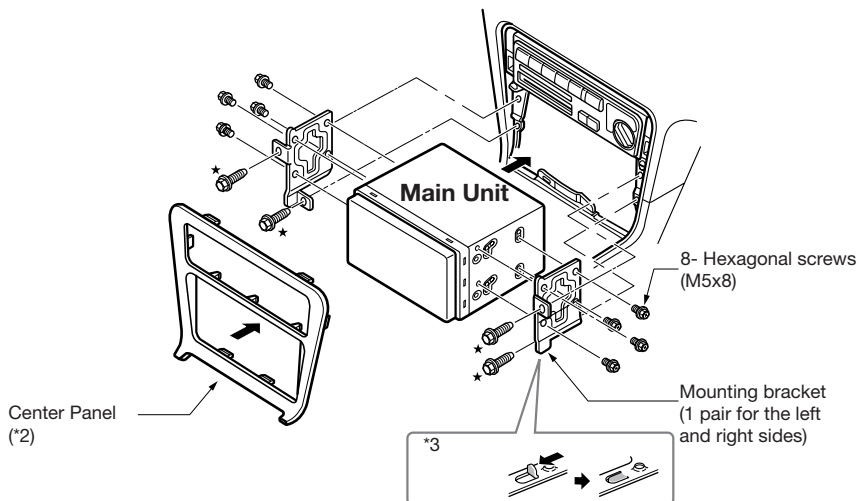
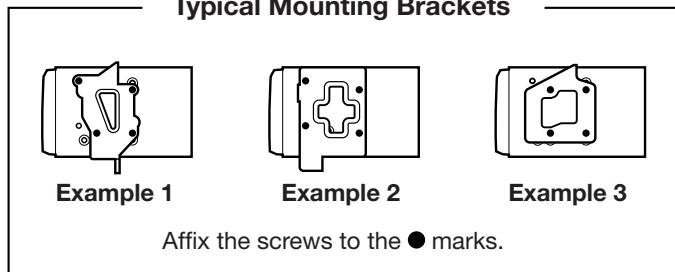

Figure 7

*2 Some panel openings are too small for the unit depending on the vehicle type and model. In such a case, trim the upper and lower sides of the panel frame by about 0.5 to 1.5 mm so the unit can be inserted smoothly.

*3 If a hook on the installation bracket interferes with the unit, bend and flatten it with a nipper or similar tool.

Typical Mounting Brackets



Vehicles other than NISSAN and TOYOTA

In some cases the center panel may require modification. (Trimming, filing, etc.)

• Removing the Main Unit

When the main unit is to be removed, disassemble it in the reverse of the order in "INSTALLING THE MAIN UNIT".

6. Cautions on Wiring

1. Be sure to turn the power off before wiring.
2. Be particularly careful where you route the wires. Keep them well away from the engine, and exhaust pipe, etc. Heat may damage the wires.
3. If the fuse should blow, check to see if the wiring is correct. If a fuse is blown, replace it with a new one of the same amperage rating as the original (15A FUSE).
4. To replace the fuse, remove the old fuse on the back of the unit and insert the new one. (Figure 8)

NOTE:

There are various types of fuse holder. Do not let the battery side touch other metal parts.

CAUTION

After the connection, fix the cord by a clamp or insulation tape for protection.

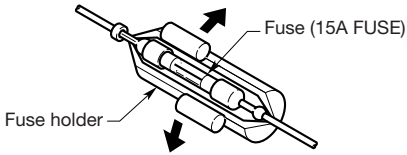
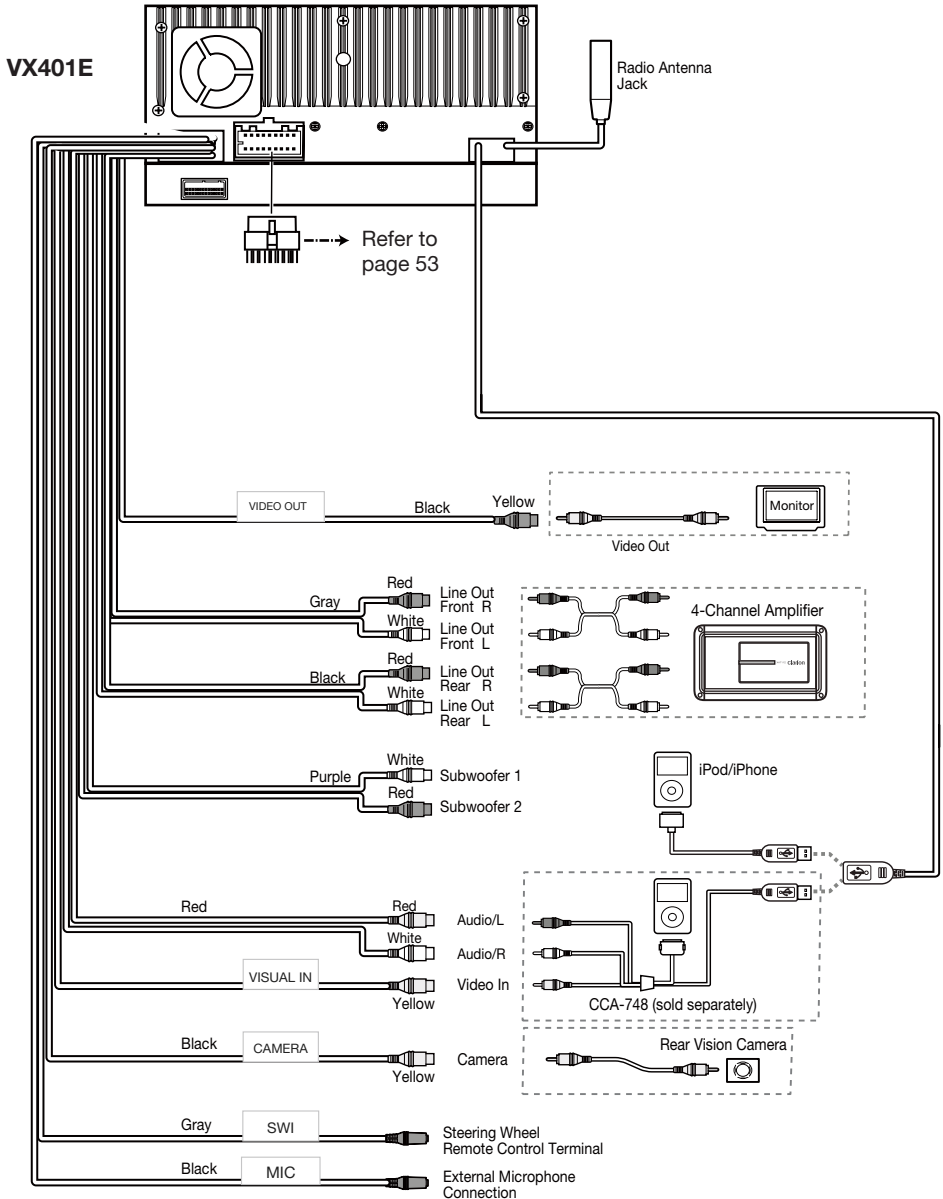

Figure 8

7. Wire Connections

Note:

- Before installing, be sure to disconnect the negative cable of the car battery.
- In the optional devices, the RCA cables and the Connector cables are separately-sold items.



VZ401E

Radio Antenna Jack

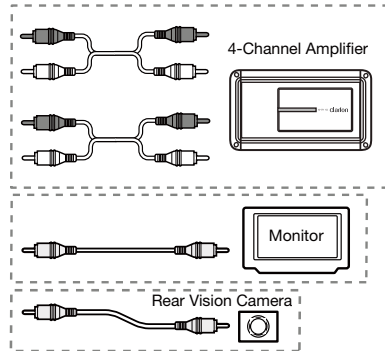
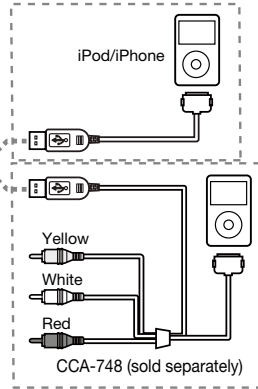
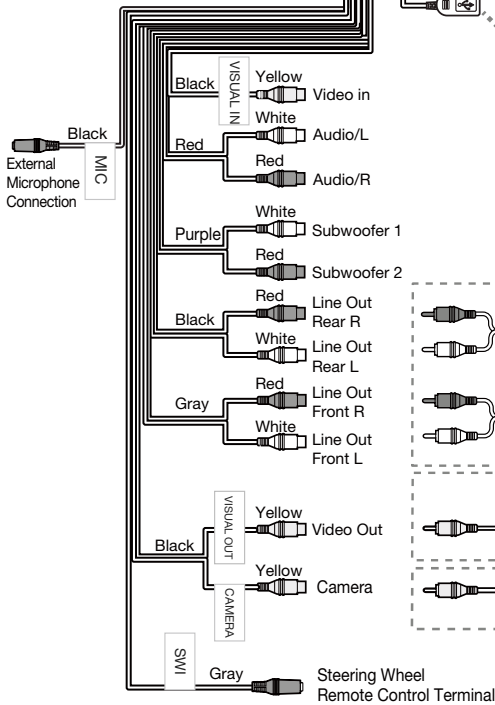
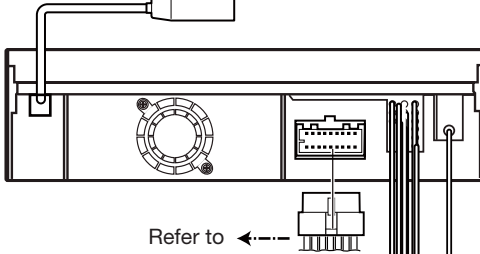

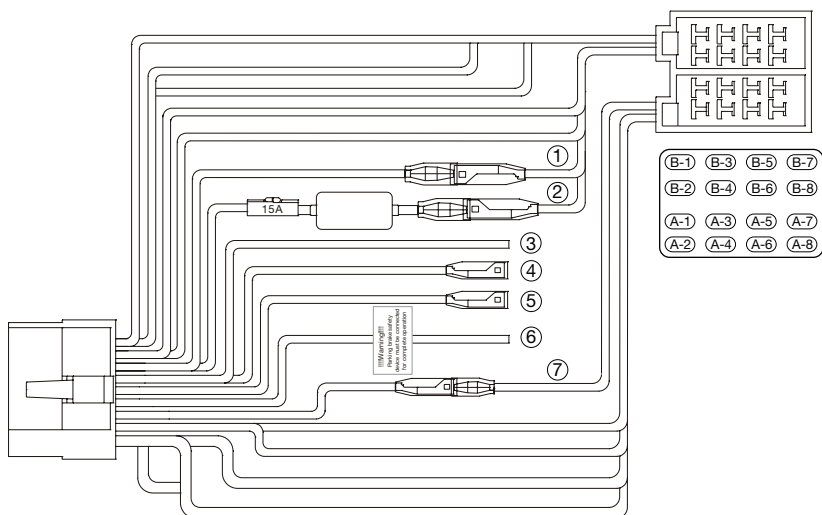

No.	Description
①	ACC(Red)
②	BACK UP(Yellow)
③	Reverse(Purple/White)
④	Phone interrupt(Brown)
⑤	Remote(Blue/White)
⑥	Parking(Grass-green)
⑦	Auto antenna(Blue)

No.	Description
(B-1)	Rear right+
(B-2)	Rear right-
(B-3)	Front right+
(B-4)	Front right-
(B-5)	Front left+
(B-6)	Front left-
(B-7)	Rear left+
(B-8)	Rear left-
(A-1)	/
(A-2)	/
(A-3)	/
(A-4)	BACK UP
(A-5)	Auto antenna
(A-6)	Illumination
(A-7)	ACC
(A-8)	GND

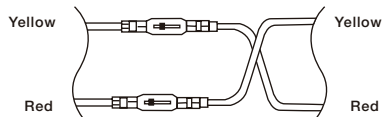

For VW and Audi: Change wiring as above

Note:

*1: Connecting the PHONE INTERRUPT terminal
The phone interrupt will mute the audio if the lead receives a negative or ground signal.

See next page for how to connect the parking brake cord.

Connecting the parking brake cord

Connect the cord to parking brake lamp ground in the meter panel.

Note:

- Connecting the parking brake cord to lamp ground allows you to watch iPod/iPhone video/DVD video/AV input when the parking brake is engaged.
- When the parking brake cord is not connected, the monitor will not show any video sources.
- If “AUDIO ONLY” appears on the screen just after turning on the ACC power of the car, release the parking brake while confirming safety, and then engage the parking brake again.

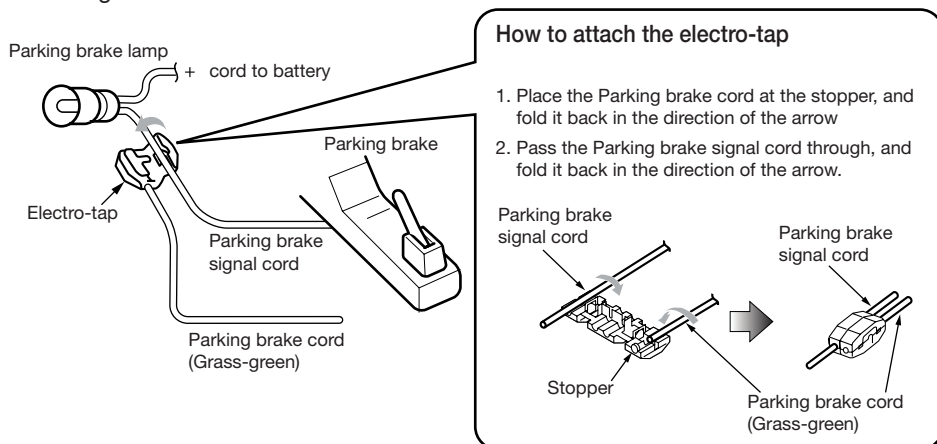

Connecting the accessories

• Connecting to the external amplifier

The external amplifiers can be connected to the 6 channel RCA output connections. Ensure that the connectors are not grounded or shorted to prevent damage to the unit.

• Connecting to iPod/iPhone device

The iPod/iPhone device can be connected to dedicated iPod/iPhone connection on the main unit. For detailed information, refer to the instruction sheet or manual for the iPod/iPhone cable.

Note:

- This unit may not support all functions of all iPod/iPhone devices.
- The iPod/ iPhone connection will charge your iPod/iPhone unless the iPod/iPhone battery is completely depleted. If the specified cord of the cellular phone is connected to the phone interrupt cord of the main unit, the audio mute is activated when cellular phone in use.



English:

Declaration of conformity

We Clarion declares that these models VX401E/VZ401E are following the provision of Directive 1999/5/EC with the essential requirements and the other relevant regulations.

Italiano:

Dichiarazione di conformità

Clarion dichiara che il presente modello VX401E/VZ401E è conforme ai requisiti essenziali e alle altre disposizioni pertinenti stabiliti dalla direttiva 1999/5/CE.

Deutsch:

Konformitätserklärung

Wir, Clarion, erklären, dass dieses Modell VX401E/VZ401E den Bestimmungen der Richtlinie 1999/5/EG im Hinblick auf die grundlegenden Anforderungen und andere relevante Bestimmungen entspricht.

Español:

Declaración de conformidad

Clarion declara que este modelo VX401E/VZ401E cumple con los requisitos esenciales y otras disposiciones aplicables descritos en la Directiva 1999/5/CE.

Français:

Déclaration de conformité

Nous, Clarion, déclarons que ce modèle VX401E/VZ401E est conforme aux exigences essentielles et aux autres dispositions pertinentes de la directive 1999/5/CE.

Italy

Dichiarazione di conformità:

Io mandatario nell' UE: Clarion Europe S.A.S. Z.I. du Pré à Varois, Route de Pompey, 54670 Custines, Francia Dichiaro che il prodotto VX401E/VZ401E è conforme al DM 28-08-1995 ottemperando alle prescrizioni dei DM 25-06-1985 e DM 27-08-1987.

Ministerial authorization FI DM 27-08-1987 n° of protocol: 0053952/0053959 date 10/08/2010

Clarion Europe S.A.S.
Z.I. du Pré à Varois, Route de Pompey, 54670 Custines, FRANCE

Clarion Co., Ltd.

All Rights Reserved. Copyright © 2010: Clarion Co., Ltd.
Printed in China / Gedruckt in China / Imprimé en Chine
Stampato in Cina / Impreso en China